

# BARN MANOIR MANUAL

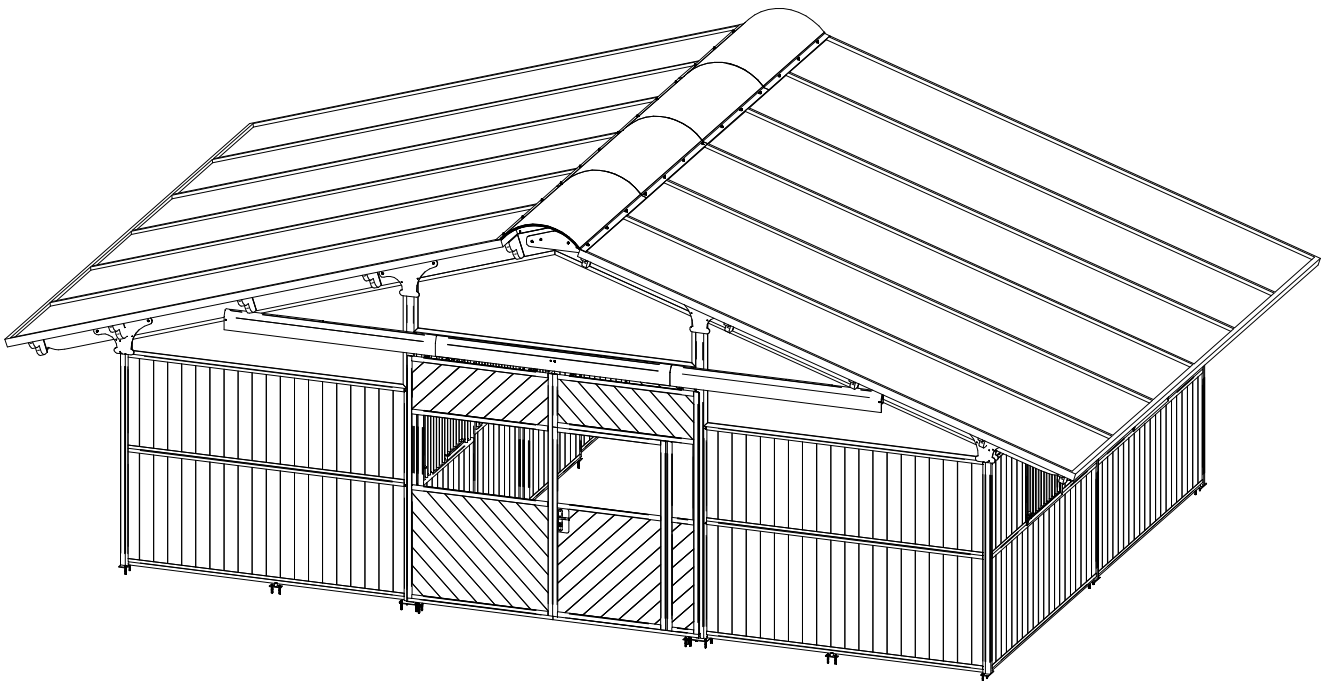

1

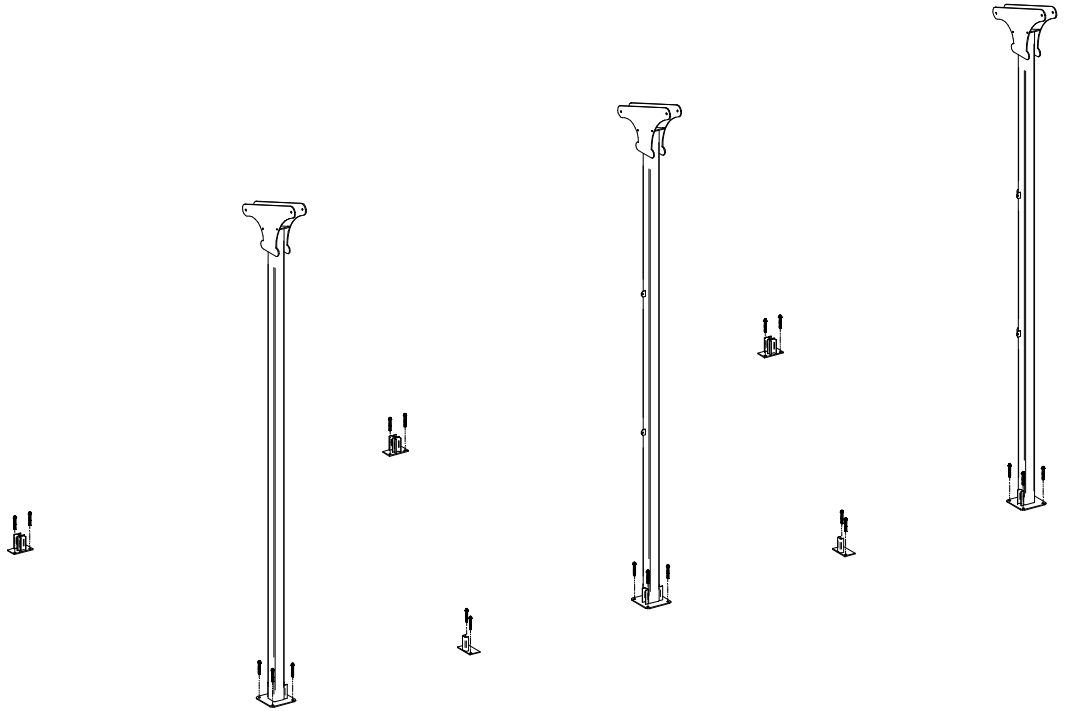

Place footings and main columns in approximate position. Make steps 2 and 3.  
Fix tripple and simple footings and columns with concrete anchors 14x80 to the ground (concrete slab) for one line of boxes.

2

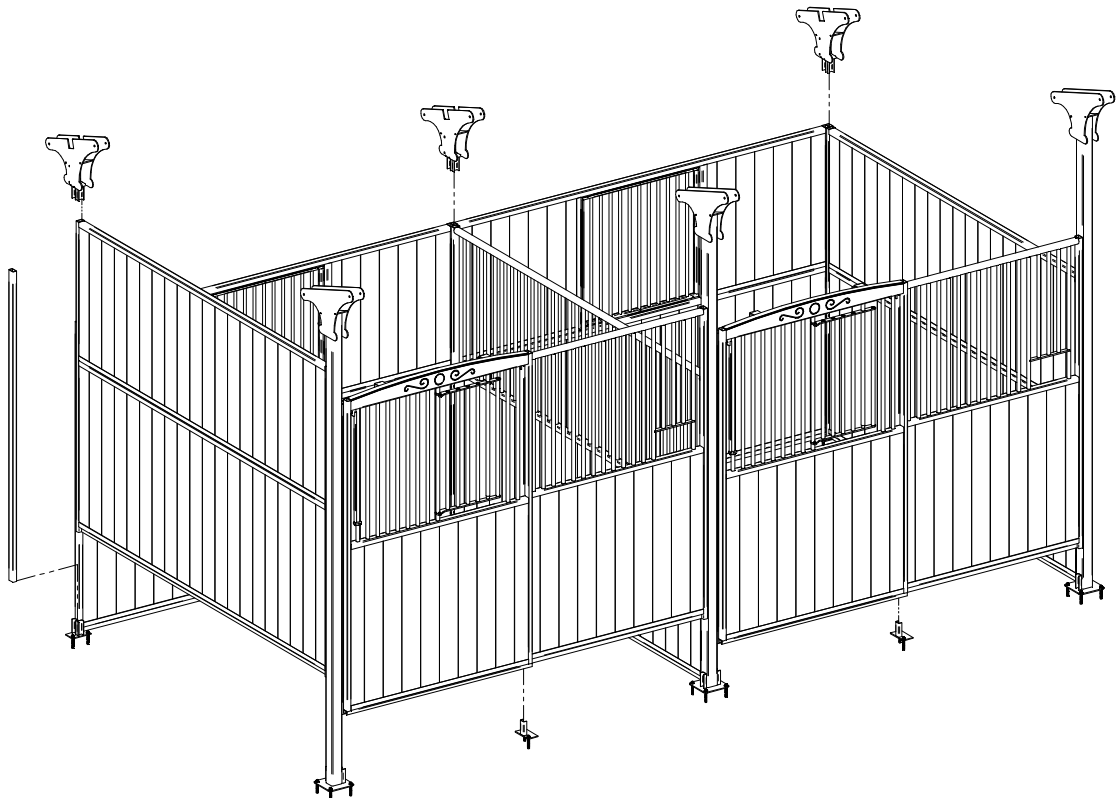

Place facades, partitions, closing posts on footings and stapling parts at the top of external wall.

3

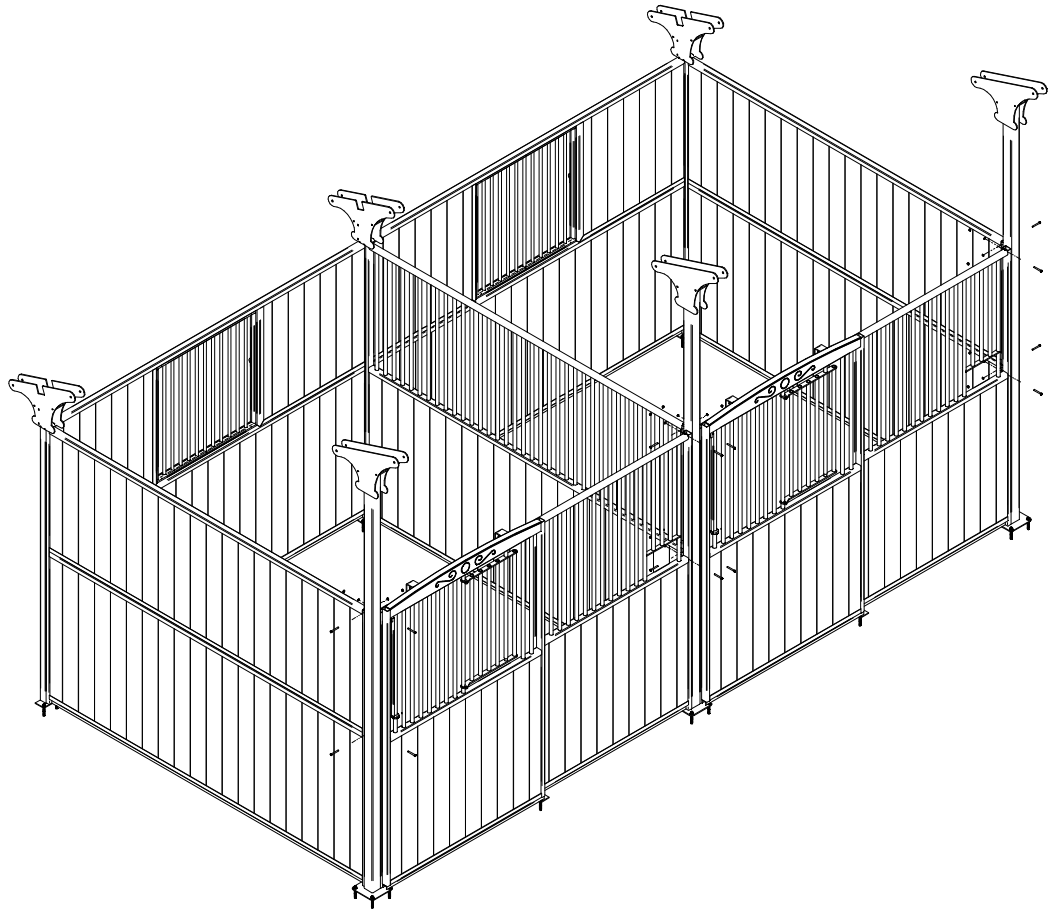

Fasten facades and partitions to main columns with bolts M8x65 +nut +washer.

4

### Detail A

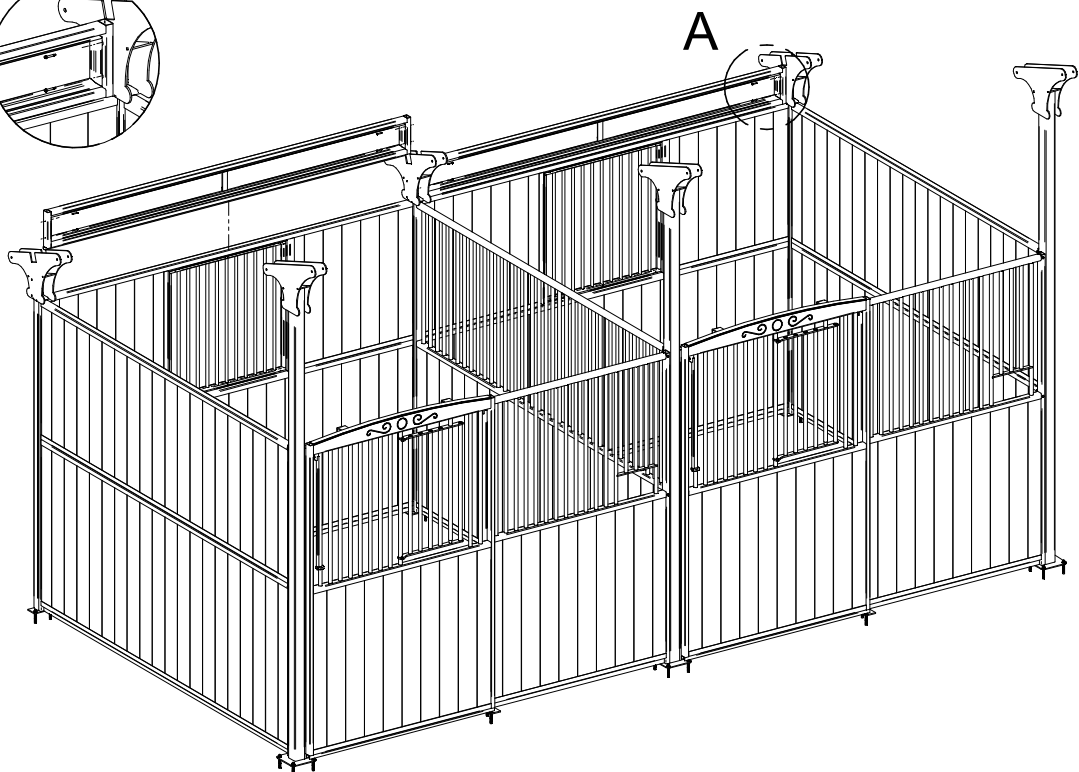
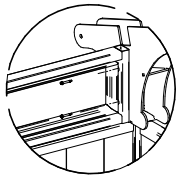

Mount top windows using self-drilling screws 5,5x40.

5

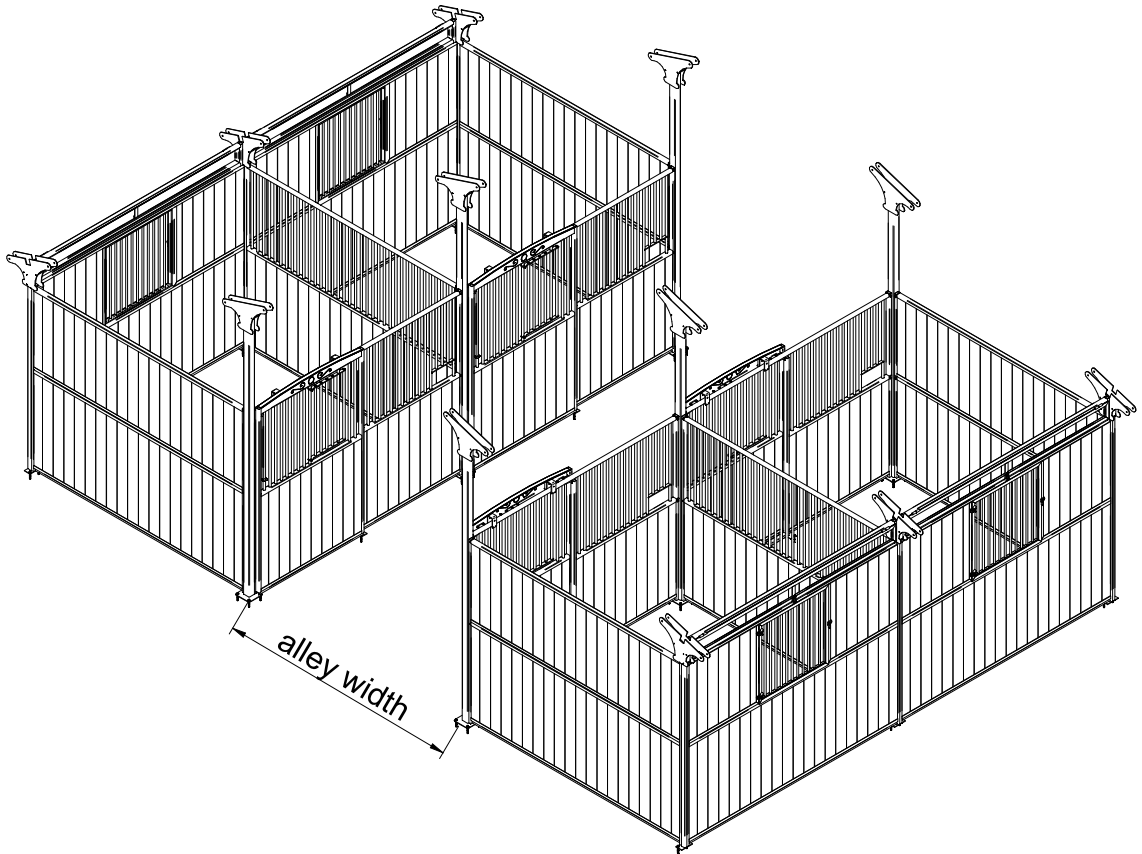

Repeat steps 1-4 for second line of boxes. Keep the distance between main columns equal to desired alley width.

6

### Detail B

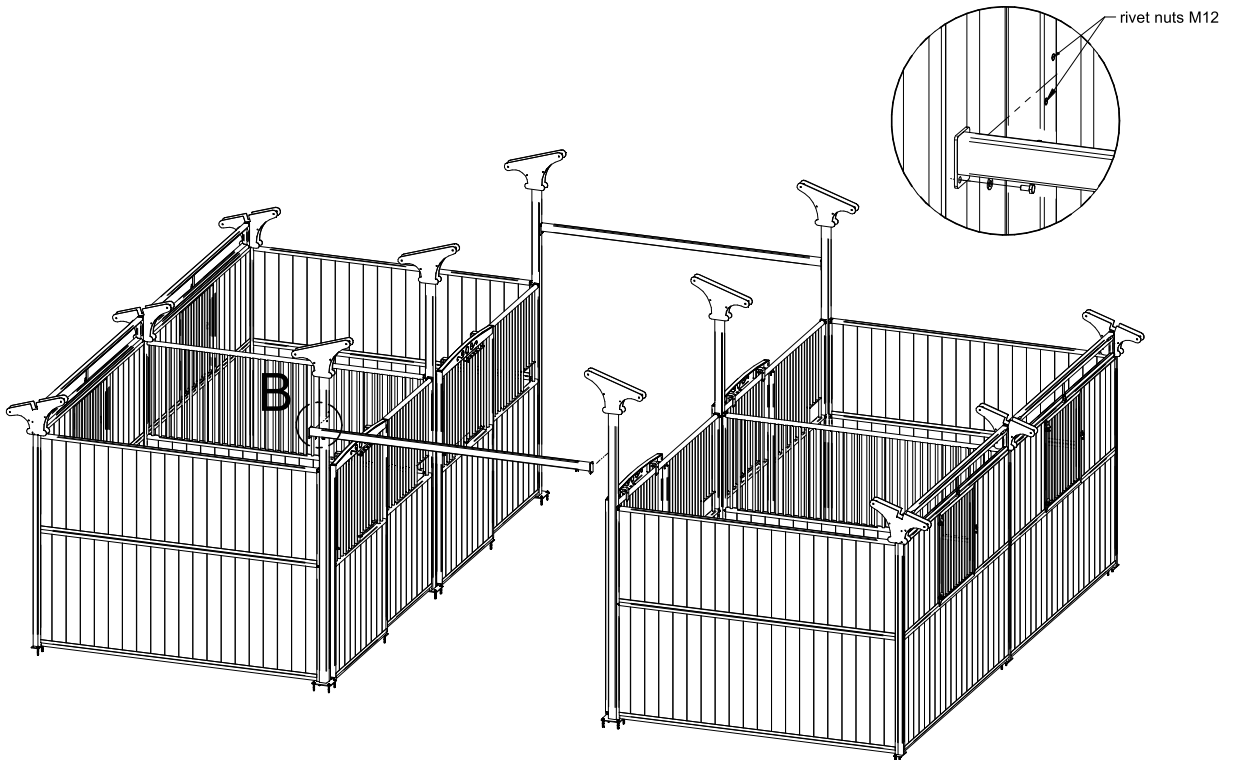

Install rivet nuts M12 in main columns and fix horizontal beams with bolts M12x30 +washer.

7

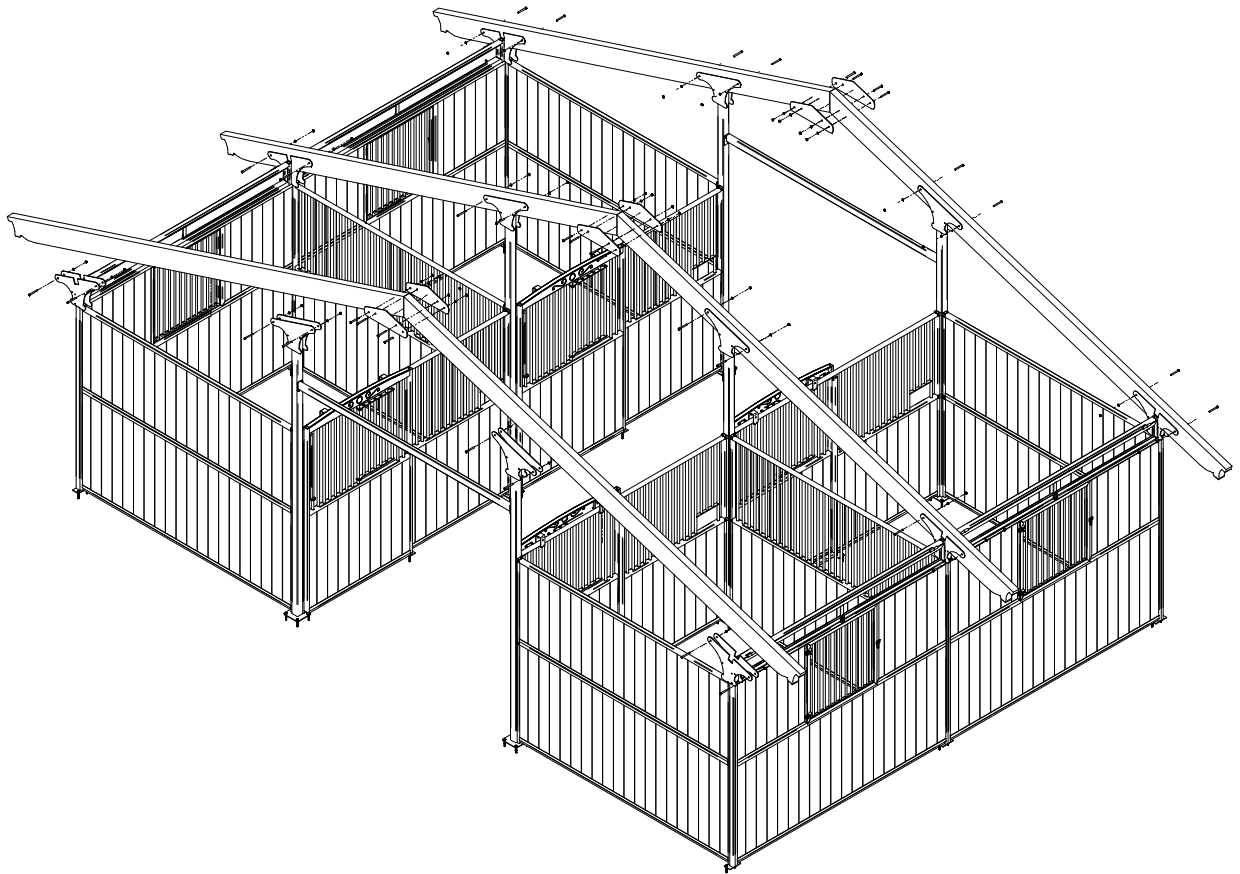

Set wooden rafters 80x240 in heads of columns. Connect rafters with apex plate. Use bolts M12x110 +nuts, +washers.

8

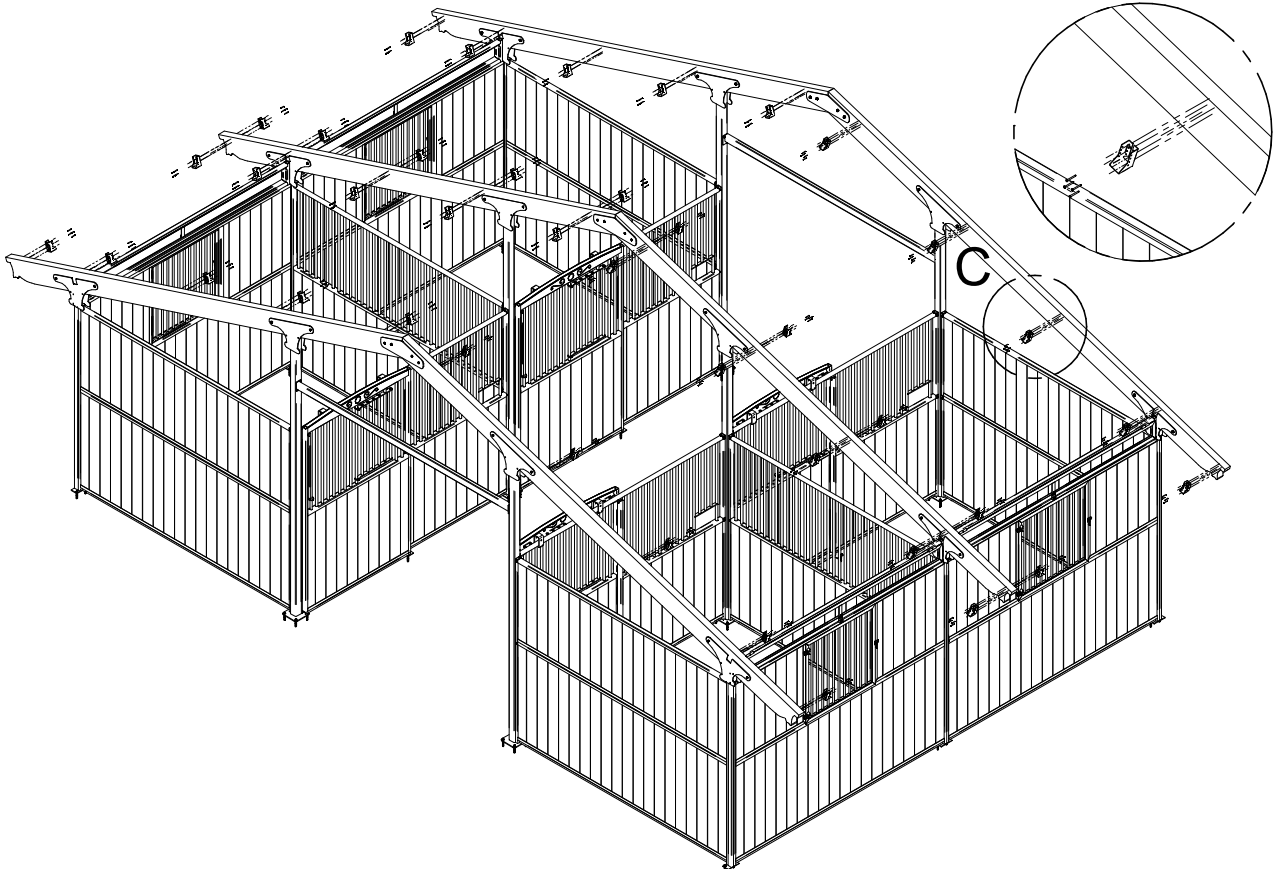

Detail C

Fix purlin holders (BMF) to rafters with wood screws 5x50.

9

Detail D

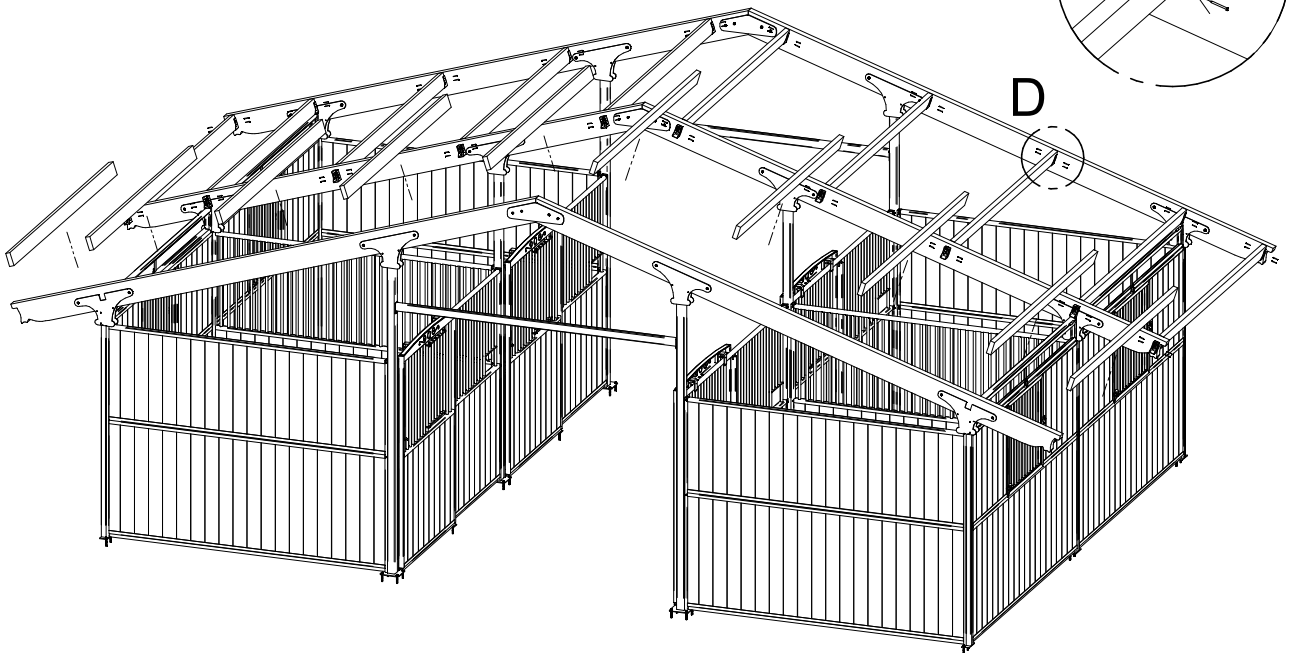

Place wooden purlins 48x140 in BMF holders and fasten with wood screws 5x50.

10

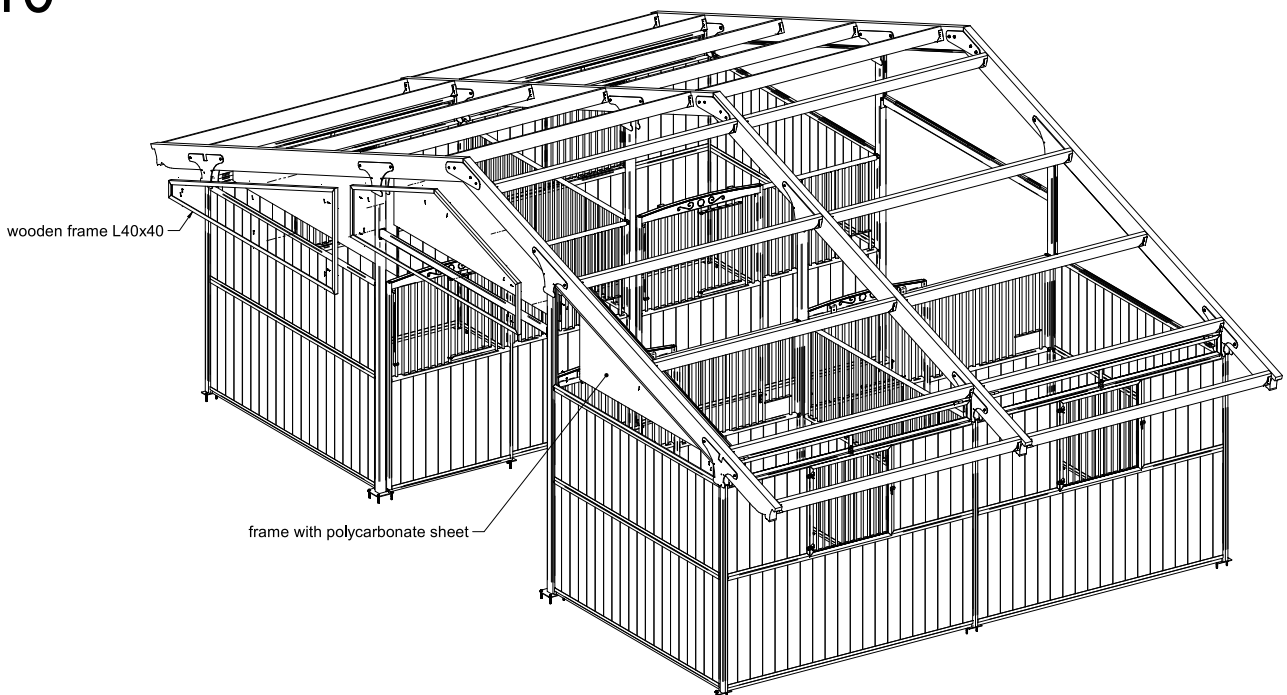

Construct frame made of wooden L40x40 for side and central part. Fix them to partitions, main columns and vertical beam with self-drilling screws 5,5x40 and to wooden rafter with wood screw 4x40. Connect the frame with polycarbonate sheet to wooden frame using SIKAFLEX glue.

# 11

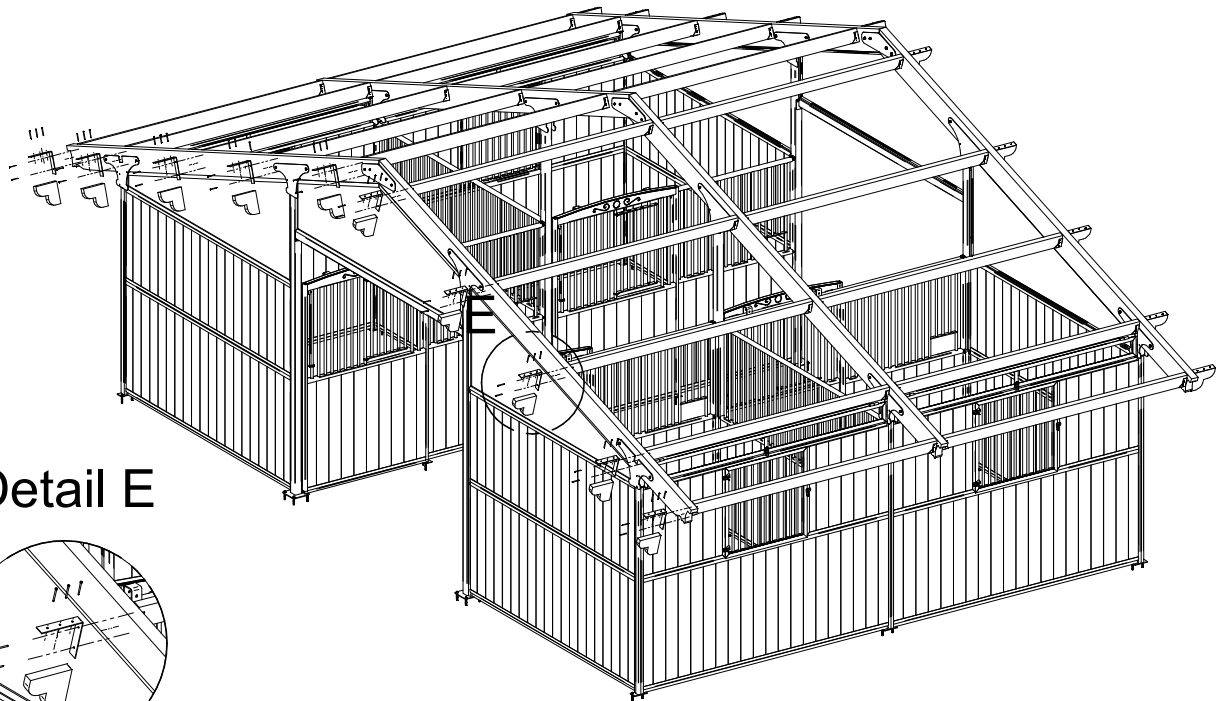

## Detail E

Install steel angle cantilever to rafters and fix to them decorative wooden part as an extending of purlins. Use wood screws 6x80.

# 12

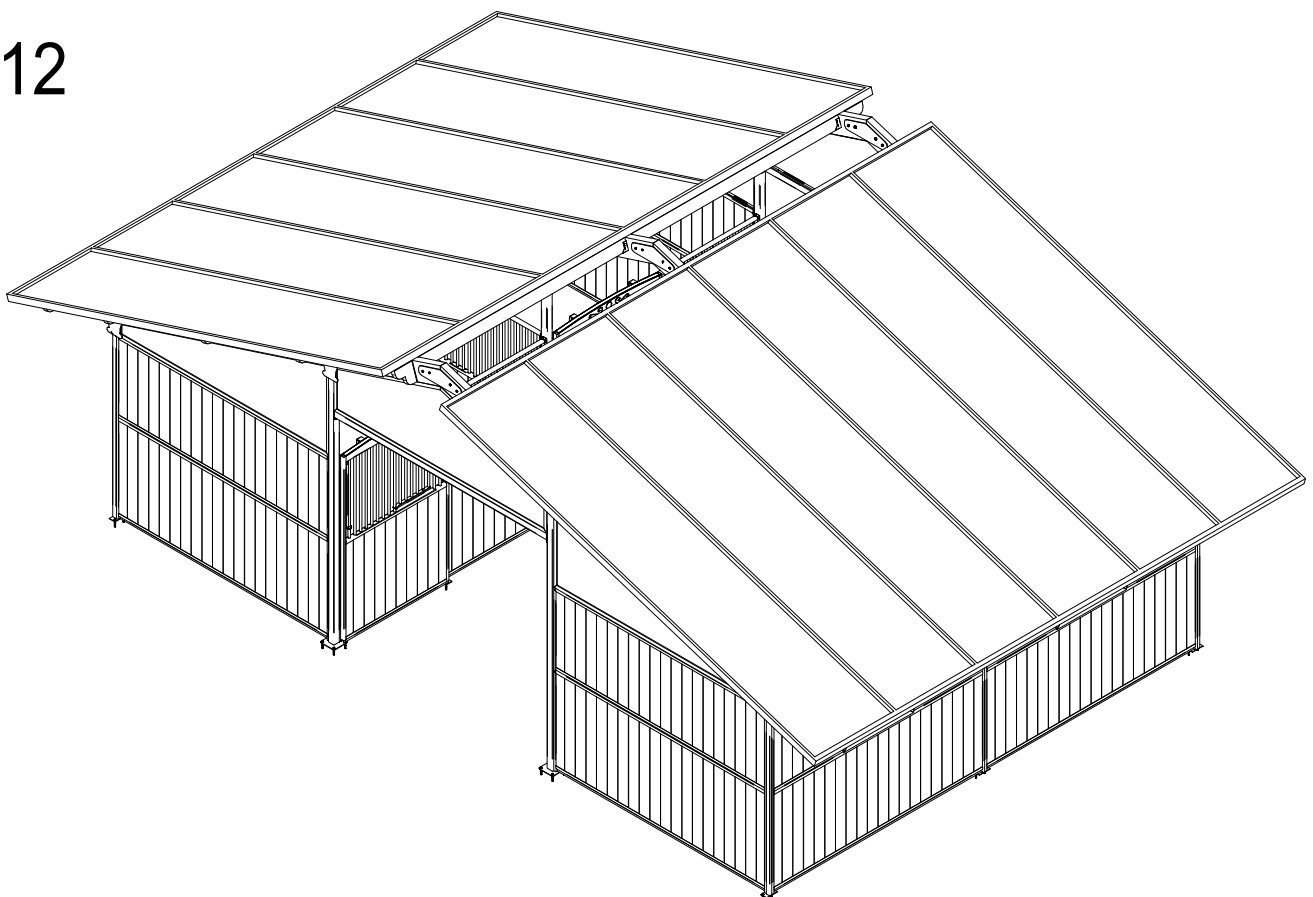

13

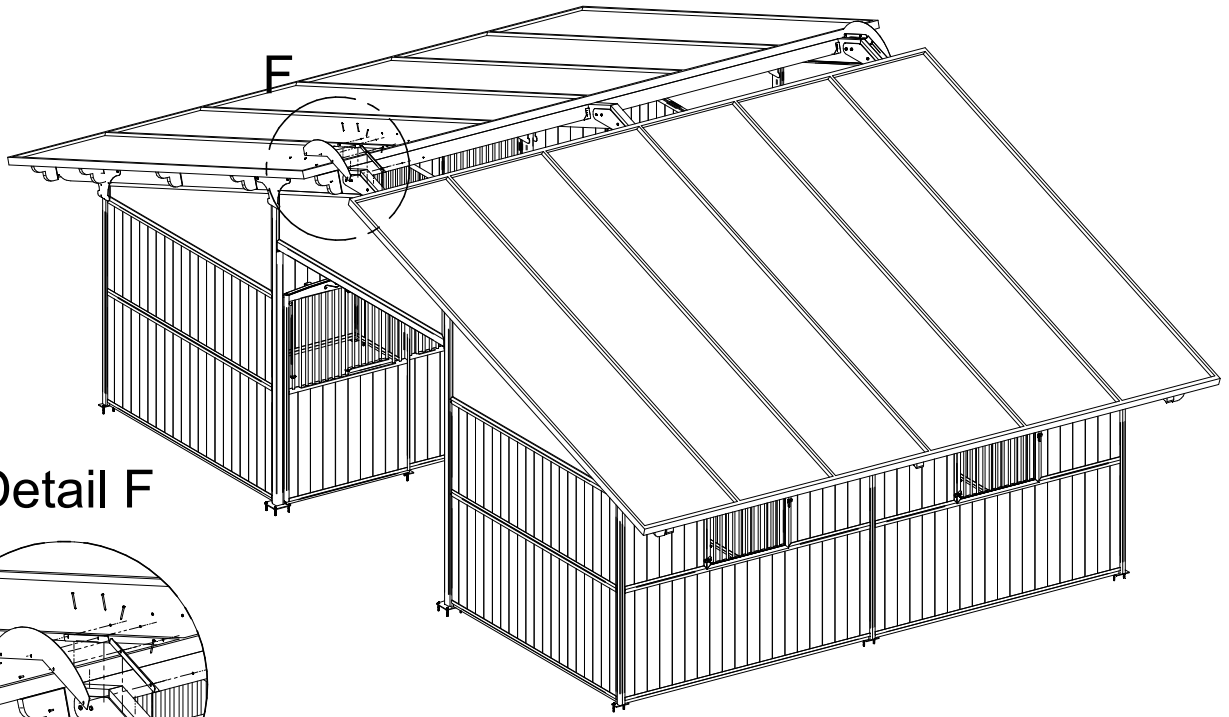

Detail F

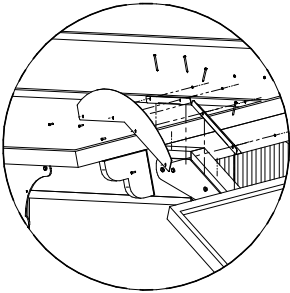

Fix angle profiles 35x35 to rafters with wood screws 6x80 and connect closing steel plate to them with bolts M6x20 +nut +washer.

14

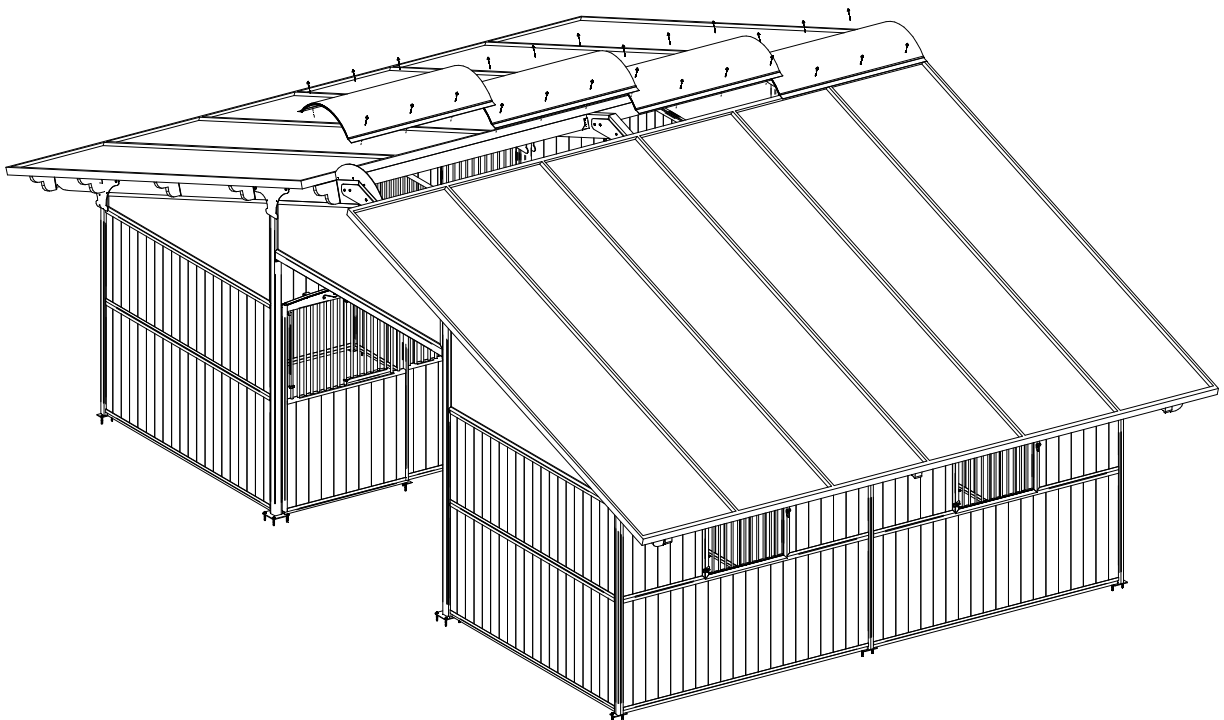

Mount skylight elements with sandwich plates fasteners.

15

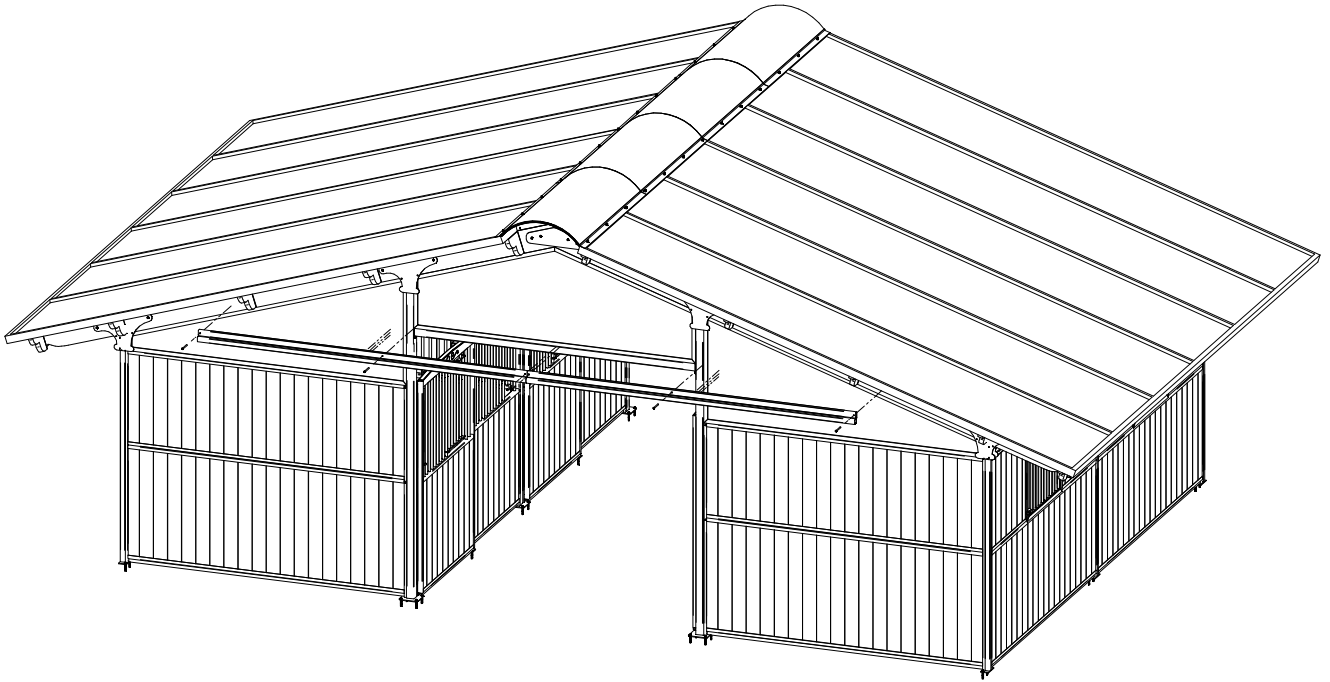

Fix rail elements to wooden rafter 80x240, main columns and vertical beam with bolts M10x120 +nut +washer.

16

Detail G

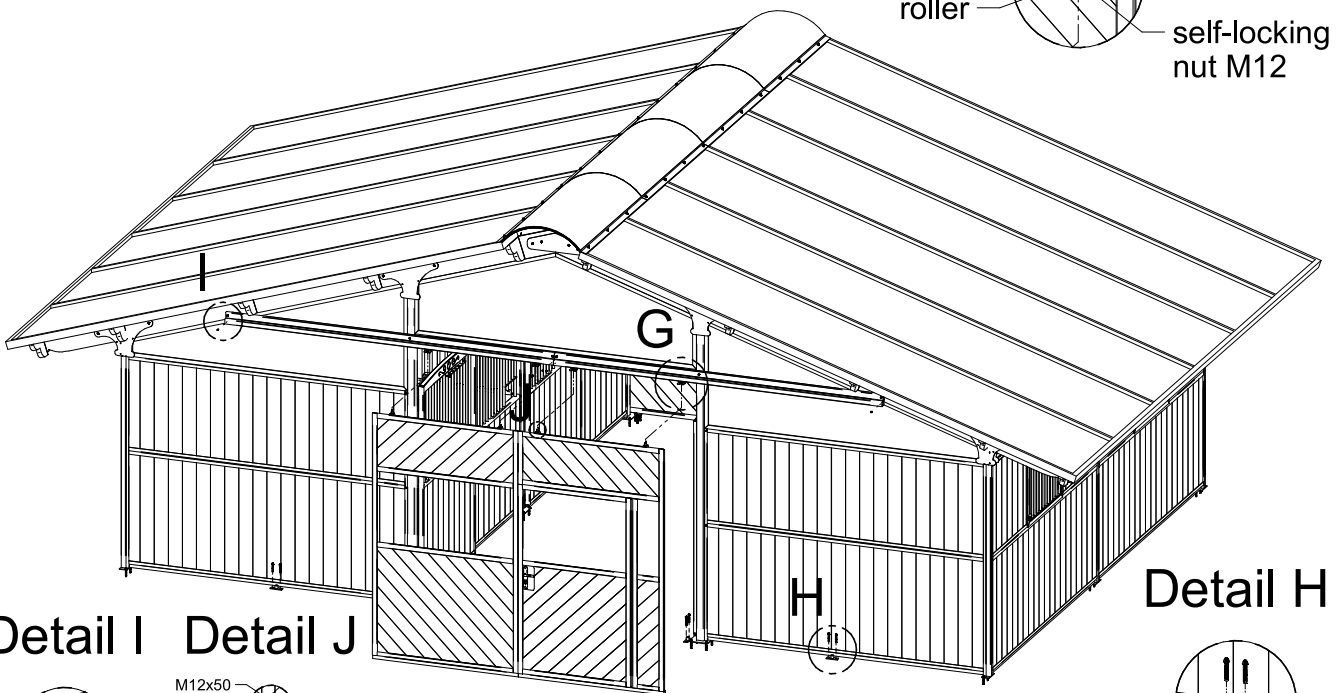
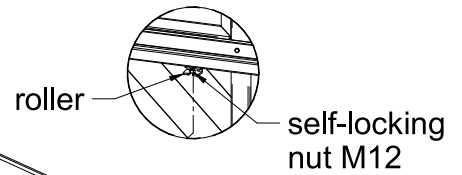

Detail I Detail J

Detail H

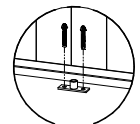
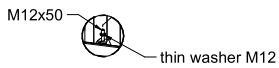
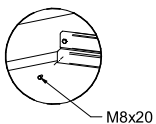

Install plates with bush by concrete anchors 14x80, push rollers into rails, fix doors with bolt M12x50 +nuts to rollers and mount bolts M8x20 +nuts at the ends of each part of rail as a blockade for rollers.

17

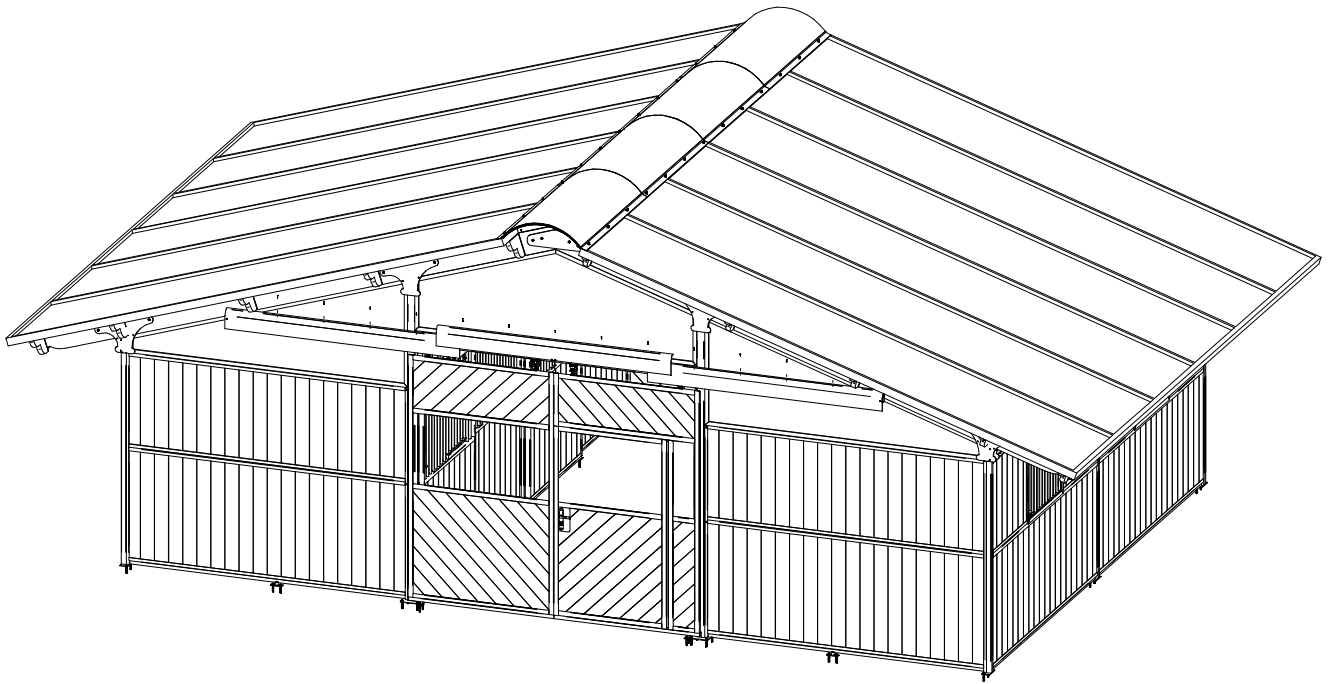

Mount flashing sheets to rails with self-drilling screws 4,8x25.

