

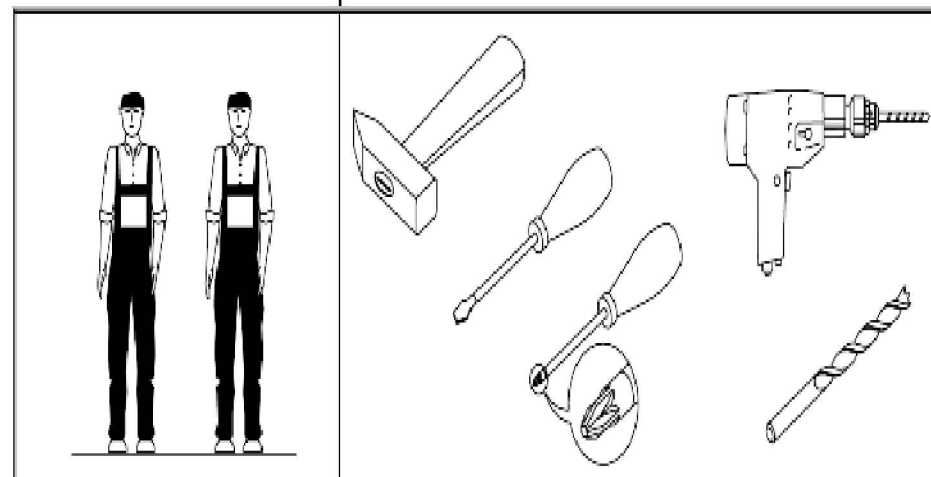

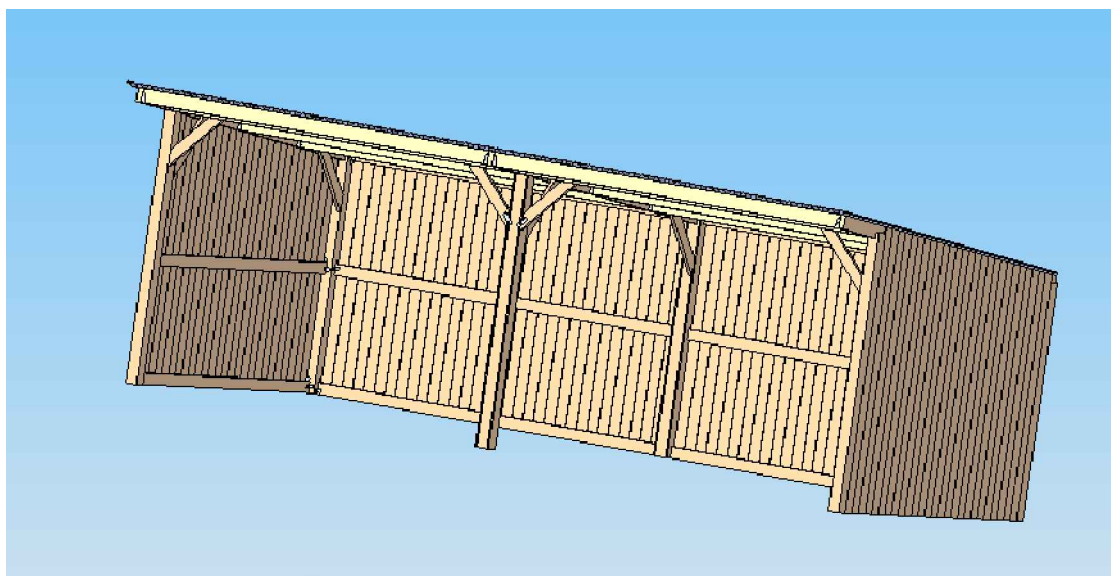







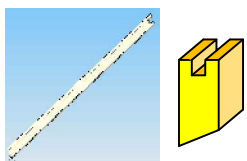
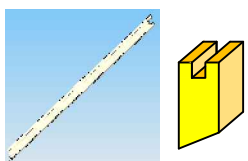

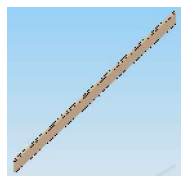
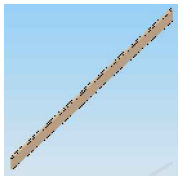
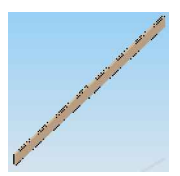
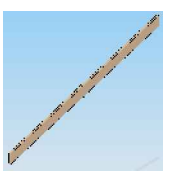

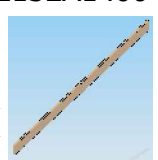



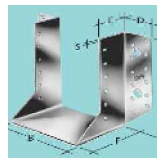
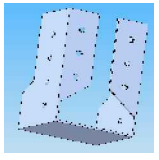

ABRI "CLASSIC" MAX

5 x 10 m

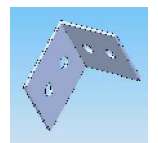
MANUAL

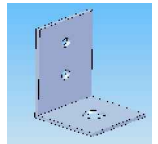

LISTE DES ELEMENTS / LIST OF ELEMENTS

<p>(A) CMSP 3 x </p> <p>Poteau 150x150x3420 Pile 150x150x3420</p>	<p>(B) CMSP 3 x </p> <p>Poteau 150x150x2920 Pile 150x150x2920</p>	<p>(C) 75 x </p> <p>Planche 18x135x3000 Plank 18x135x3000</p>	<p>(D) 65 x </p> <p>Planche 18x135x3500 Plank 18x135x3500</p>	<p>(E) 6 x </p> <p>Planche 18x135x3420 Plank 18x135x3420</p>	
<p>(F) 3 x </p> <p>Panne 70x170x5000 Patch 70x170x5000</p>	<p>(G) 8 x </p> <p>Panne 70x170x4980 Patch 70x170x4980</p>	<p>(H) 2132A5050 6 x </p> <p>Panne 48x140x5050 Patch 48x140x5050</p>	<p>(I) 2132A4050 4 x </p> <p>Panne 48x140x4050 Patch 48x140x4050</p>	<p>(J) 2132A1400 10 x </p> <p>Panne 48x140x1400 Patch 48x140x1400</p>	<p>(K) 2130TG 11 x </p> <p>Toile trapeze L=5100 mm Galvanized sheet metal</p>
<p>(1) VP 870 400 x </p> <p>Vis a bois 8x60 wood screw 8x60</p>	<p>(2) 180 x </p> <p>Vis a bois a toile trapeze screw of sheet metal</p>	<p>(3) 12 x </p> <p>BMF 76x120 (03218.00)</p>	<p>(4) 4 x </p> <p>BMF 76x120 (03218.001)</p>	<p>(5) 96 x </p> <p>Vis a bois 8x50 BMF BMF screw 8x50</p>	<p>(6) 20 x </p> <p>Vis a pannes 5x40 wood screw 5x40</p>
<p>(7) 4 x </p> <p>Vis romain fi 12 Roman screw fi 12</p>	<p>(8) 8 x </p> <p>Cornreventements stud bar</p>	<p>(6) 20 x </p> <p>Vis a bois 10x80 wood screw 10x80</p>	<p>(10) 54 x </p> <p>Corniere de montage Angle bar</p>	<p>(11) VB1480 12 x </p> <p>Chevilles a beton 14x80 Anchor 14x80</p>	<p>(12) VP 650 120 x </p> <p>Vis a bois 6x50 wood screw 6x50</p>
<p>(13) VP 880 30 x </p> <p>Vis a bois 8x80 wood screw 8x80</p>	<p>(14) 12 x </p> <p>Pied bas - cornieres Angle bar</p>	<p>(15) 12 x </p> <p>Platine perforee Plate</p>			



PANNEAU DROIT
RIGHT WALL

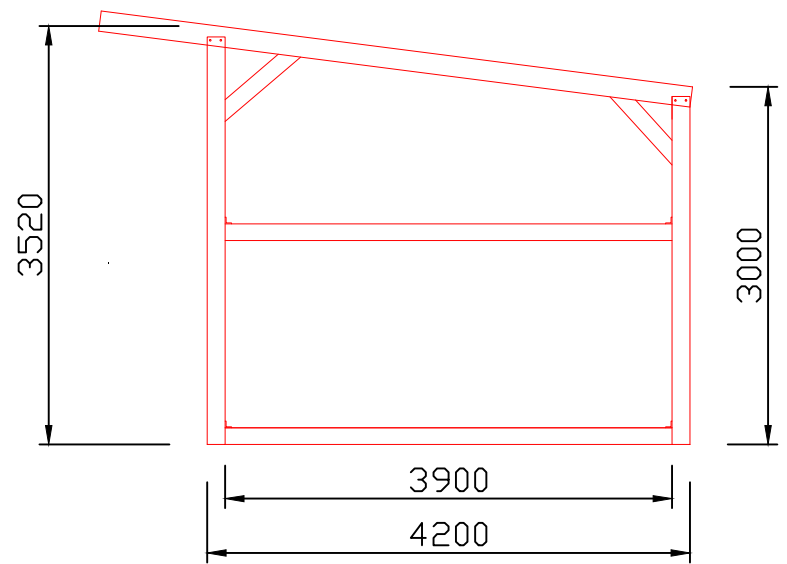

PANNEAU GAUCHE
LEFT WALL

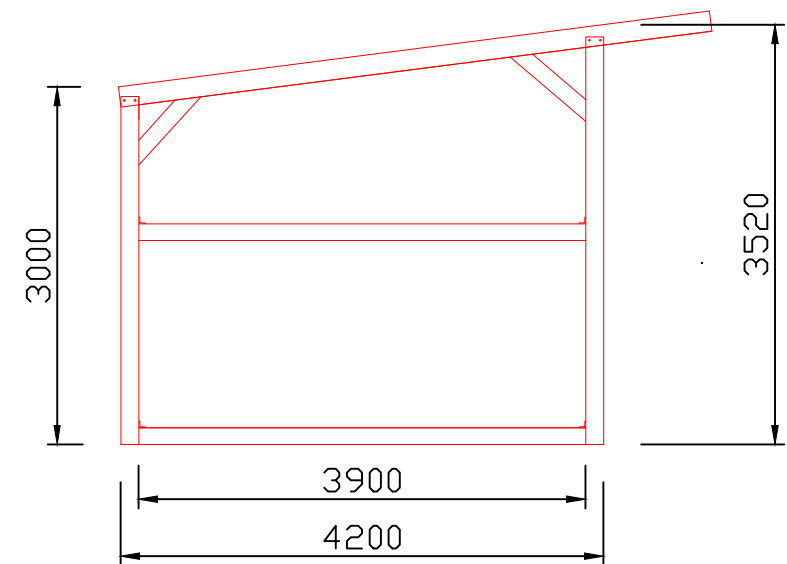

PANNEAU AU MILIEU
CENTER WALL

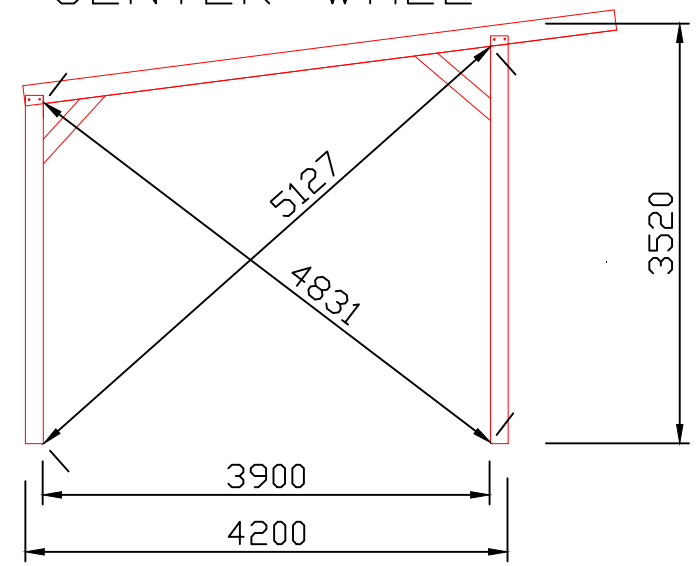

BMF montage / BMF assembling

PANNEAU GAUCHE
LEFT WALL

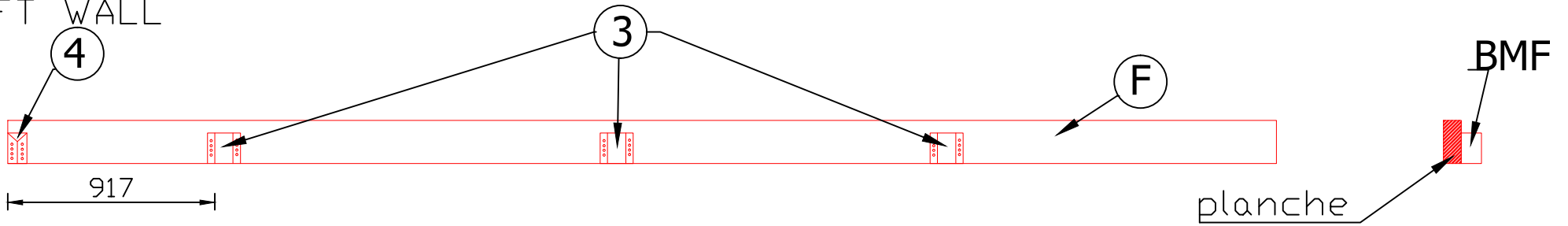

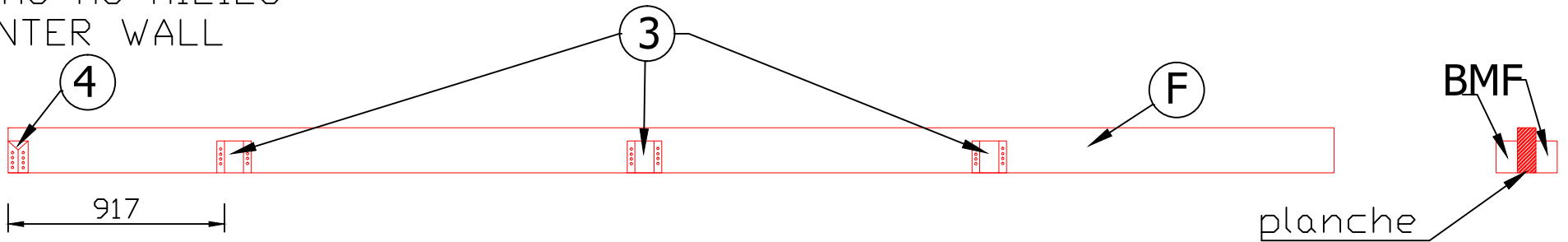

PANNEAU AU MILIEU
CENTER WALL

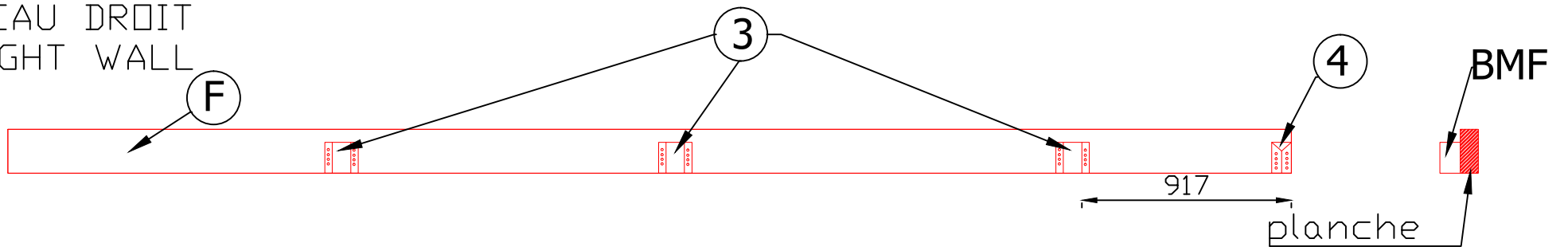

PANNEAU DROIT
RIGHT WALL

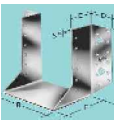
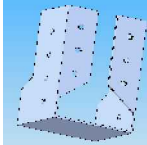

<p>(F)</p> <p>3 x</p> 	<p>(3)</p> <p>12 x</p> 	<p>(4)</p> <p>4 x</p> 	<p>(5)</p> <p>96 x</p> 
---	--	---	--

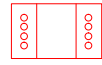

(5)

3 x →  ← x 3

scier/cutting

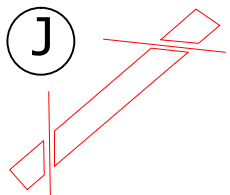

Vue a l'exterieur abri
View outside of Abri

PANNEAU DROIT
RIGHT WALL

3/13

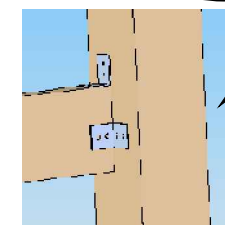
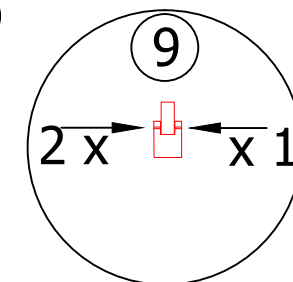
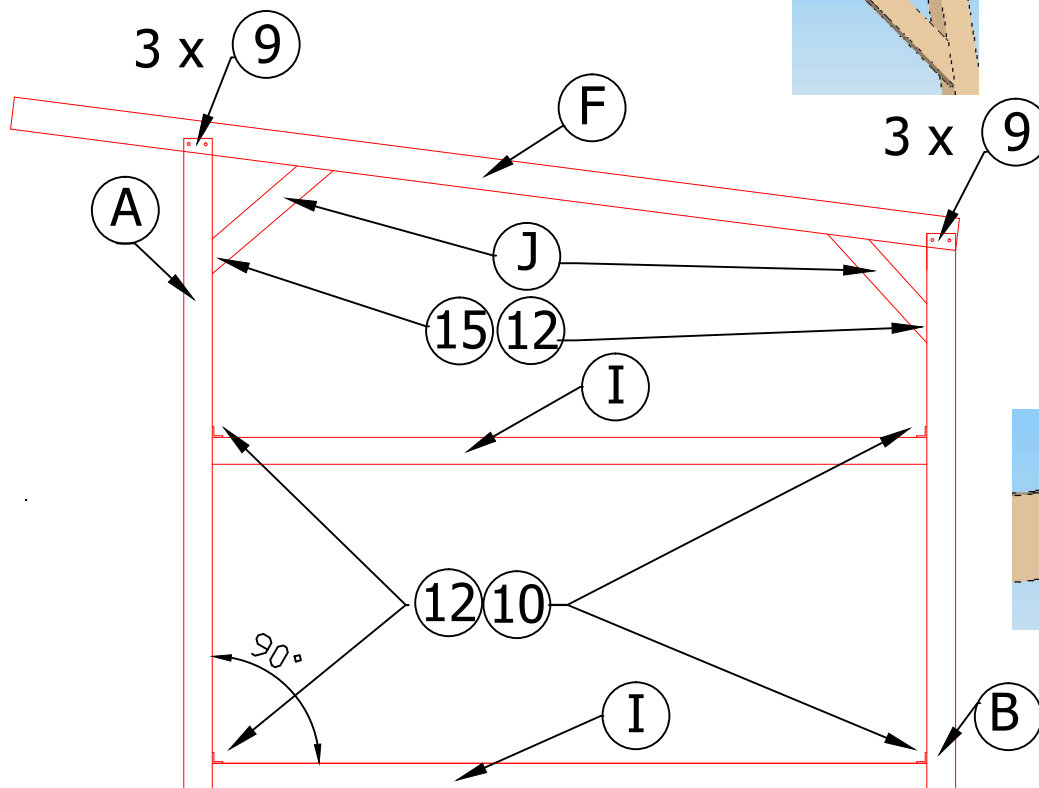
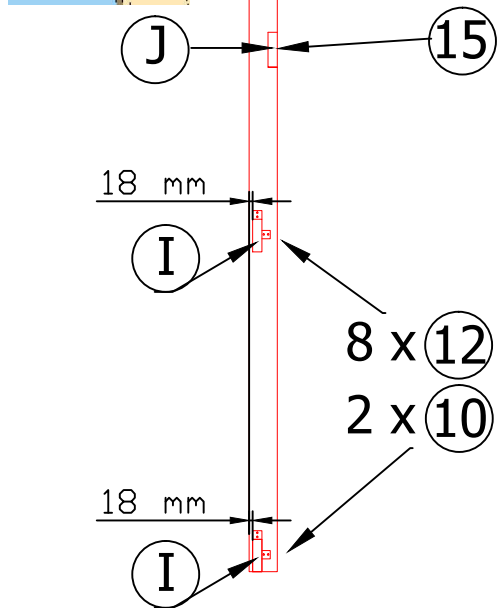
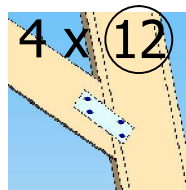

Vue interieur
View inside

(A)



(B)

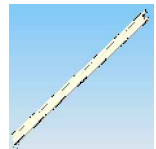

(I)



(J)

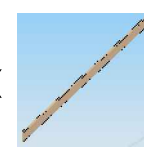

(F)



(9)

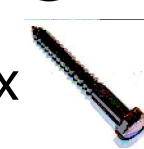

(10)

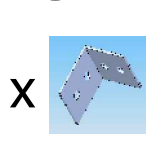

(12)



(15)



1 x

1 x

2 x

2 x

1 x

6 x

8 x

40 x

2 x

PANNEAU GAUCHE
LEFT WALL

Vue a l'exterieur abri
View outside of Abri

scier/cutting

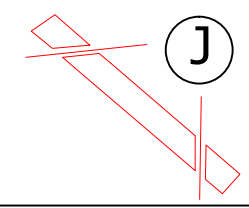





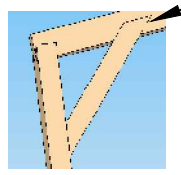

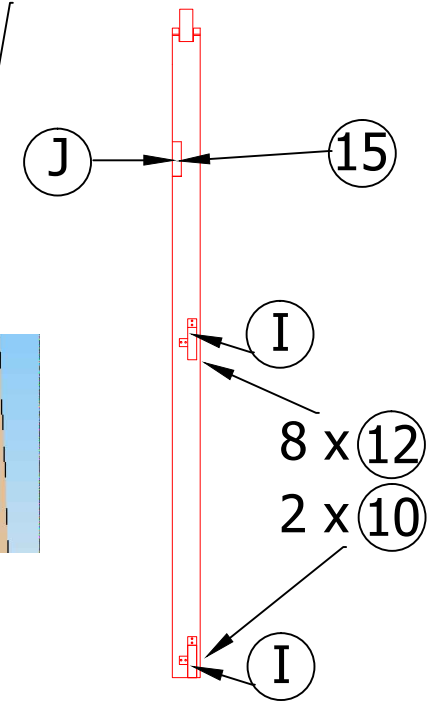
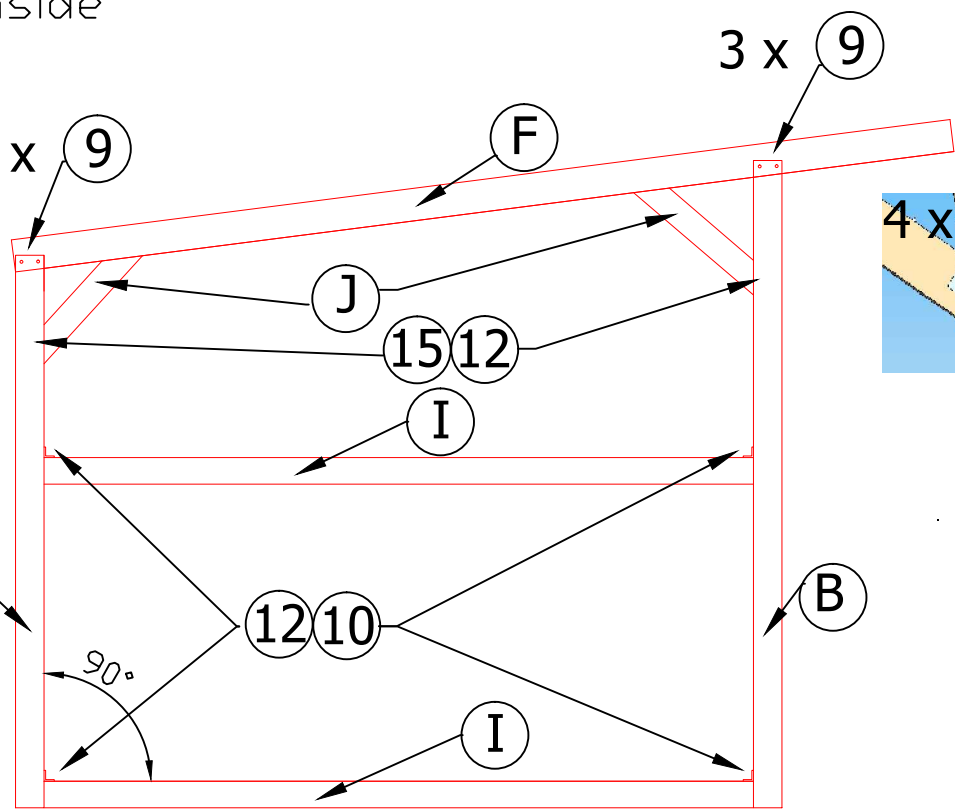
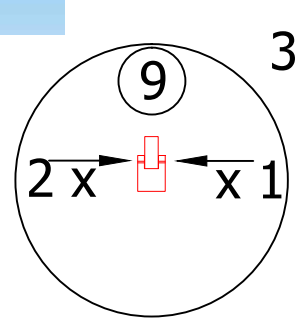
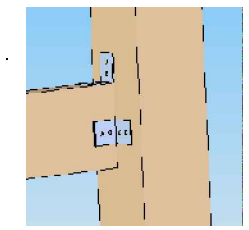
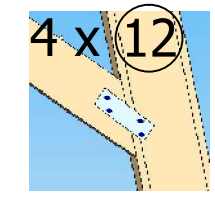

4/13

Vue interieur
View inside

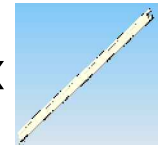

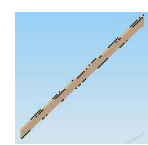
Vue interieur
View inside

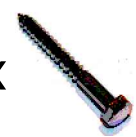
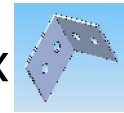

<p>(A)</p> <p>1 x </p>	<p>(B)</p> <p>1 x </p>	<p>(I)</p> <p>2 x </p>	<p>(J)</p> <p>2 x </p>	<p>(F)</p> <p>1 x </p>	<p>(9)</p> <p>6 x </p>	<p>(10)</p> <p>8 x </p>	<p>(12)</p> <p>40 x </p>	<p>(15)</p> <p>2 x </p>
--	---	---	---	---	---	--	---	--

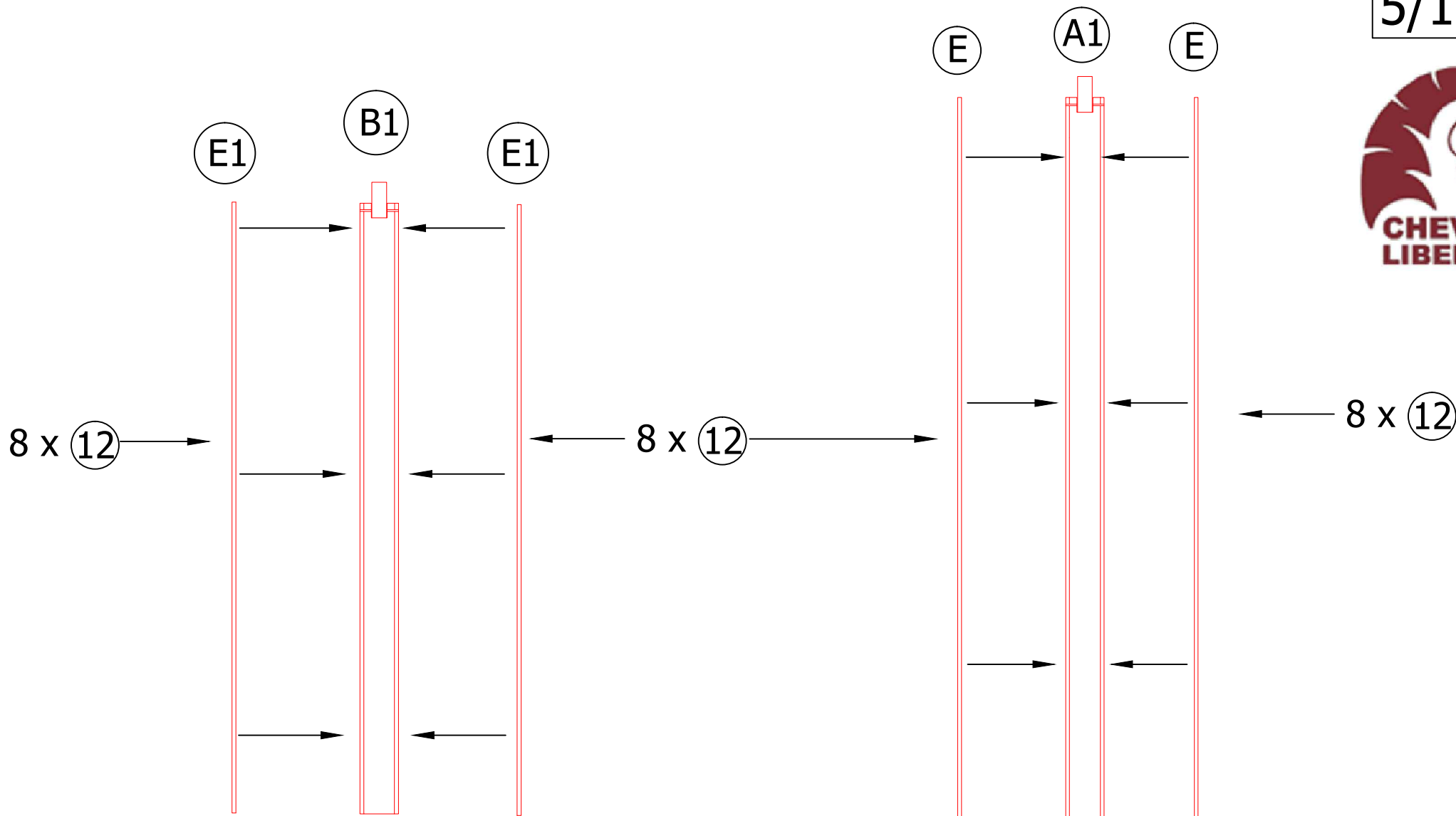

A

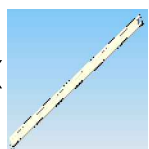

B



12

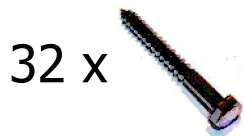

1 x

1 x

32 x

PANNEAU AU MILIEU
CENTER WALL

Vue a l'interieur Abri
View outside of Abri

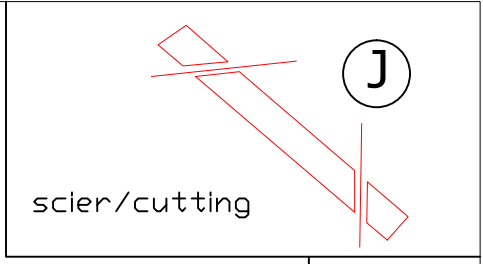

6/13

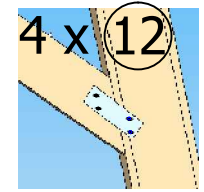
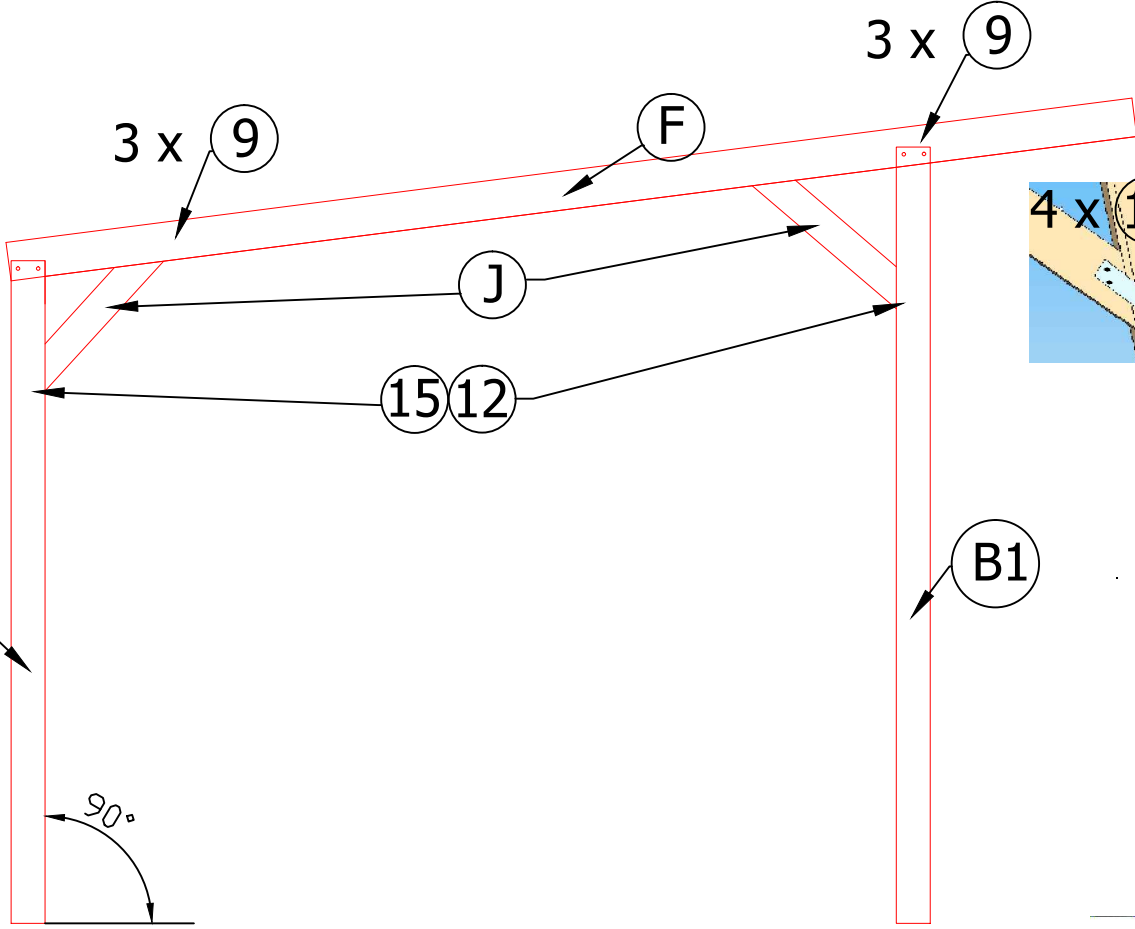
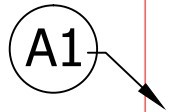
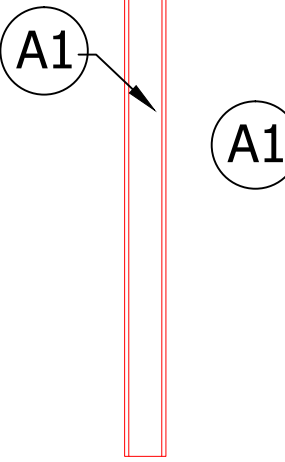
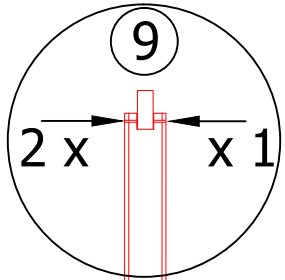
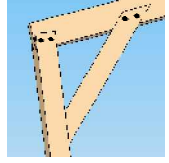

Vue interieur
View inside

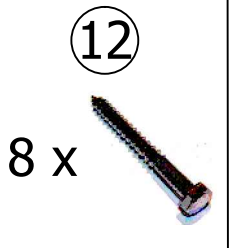
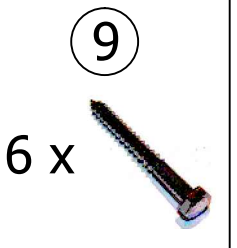
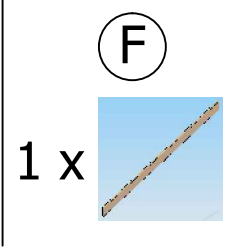
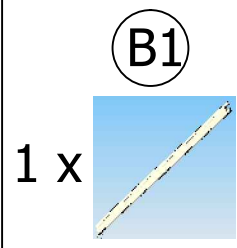
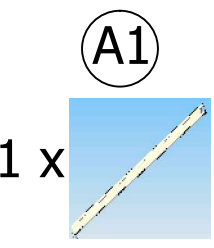
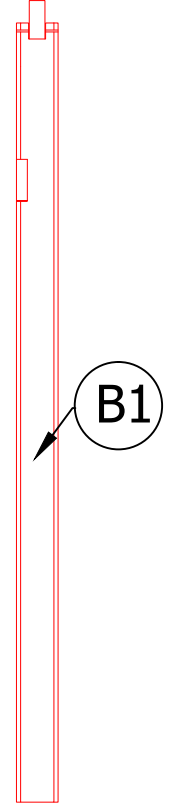

Panneau Arrier Back wall

7/13

PANNEAU GAUCHE
LEFT WALL

PANNEAU AU MILIEU
CENTER WALL

PANNEAU DROIT
RIGHT WALL

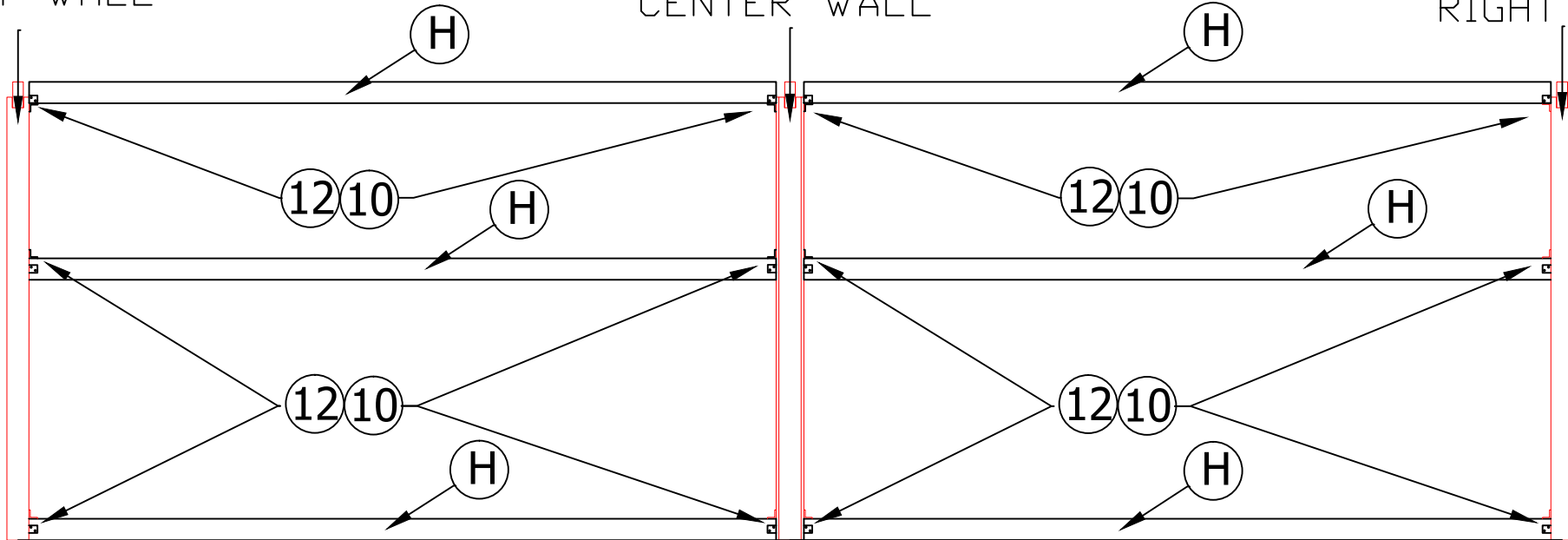

10

24 x



12

96 x



1 x
PANNEAU GAUCHE
LEFT WALL

1 x

PANNEAU AU MILIEU
CENTER WALL

1 x

PANNEAU DROIT
RIGHT WALL

H

6 x

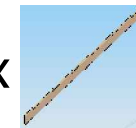

Enface/front

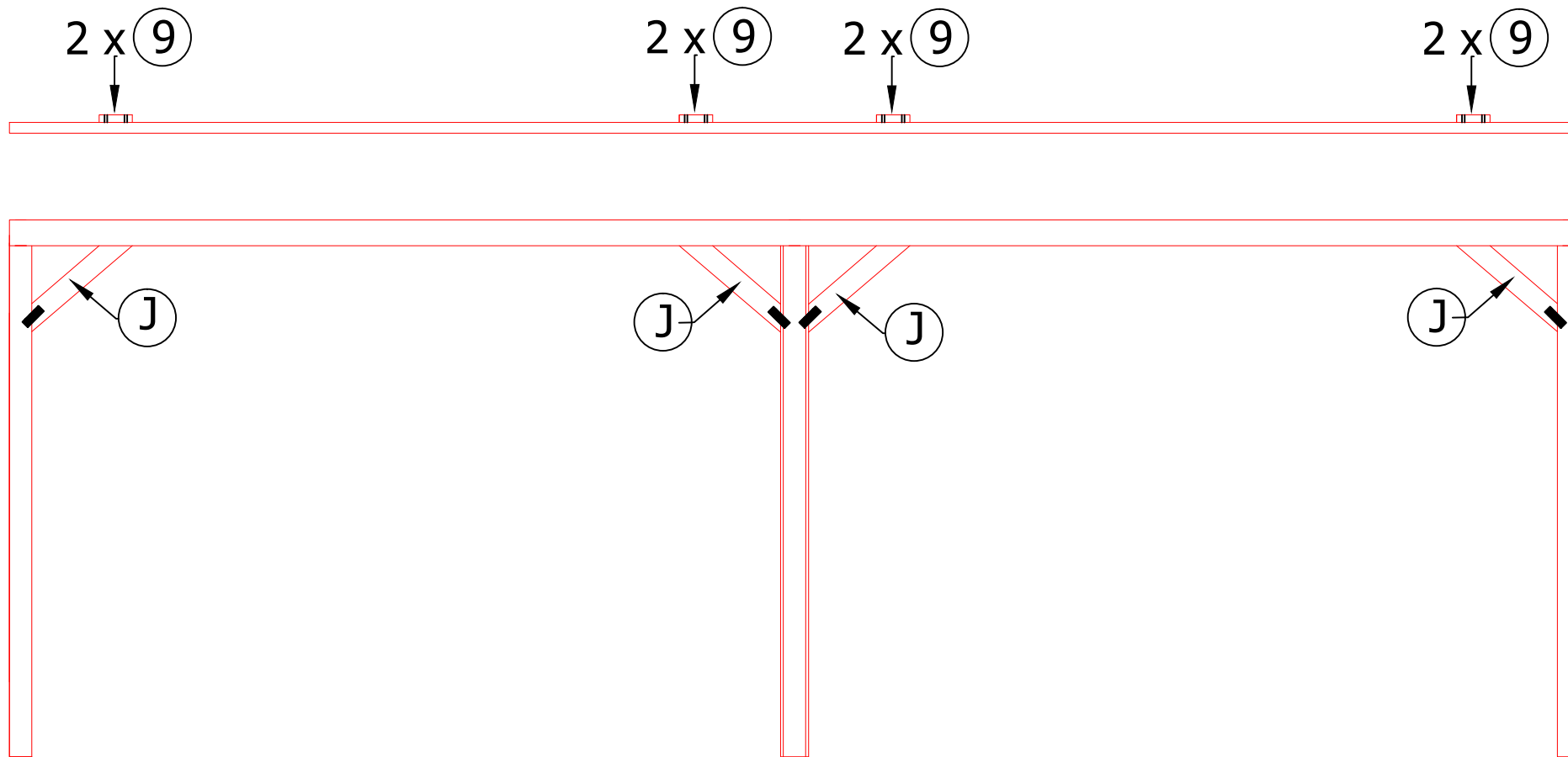

9



8 x

J



4 x

15



4 x

12



16 x



Toit/roof

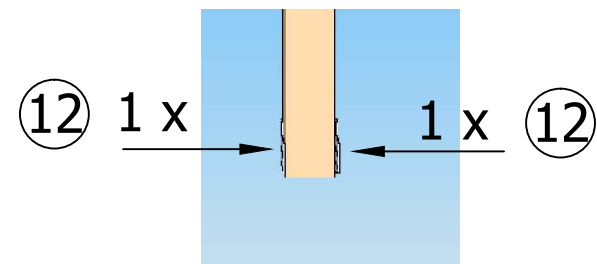
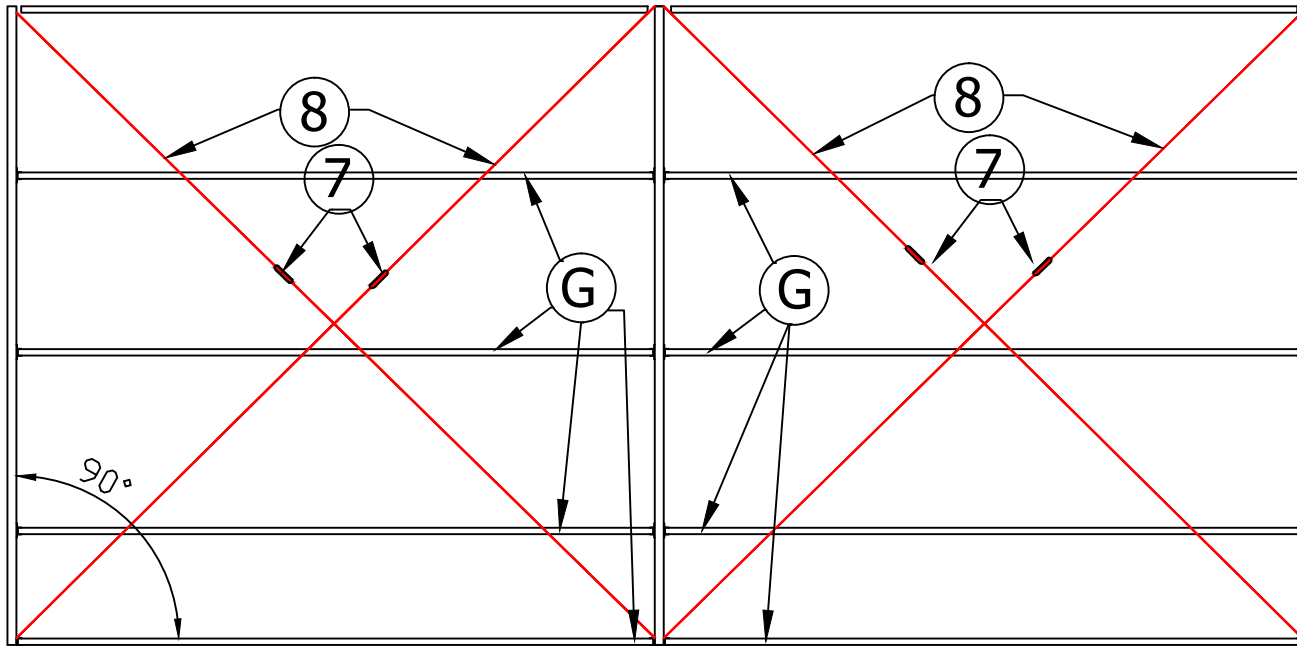
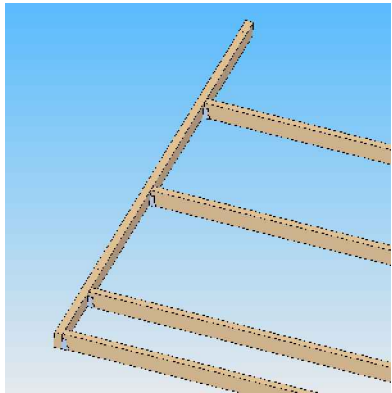
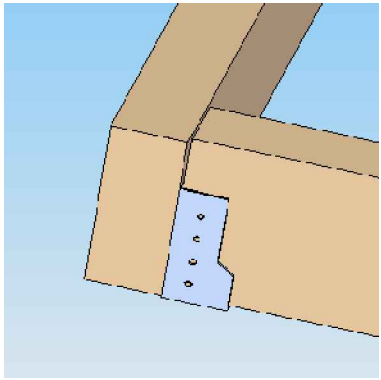

G

6

8

7

8 x

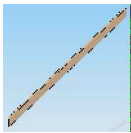

20 x



8 x



4 x



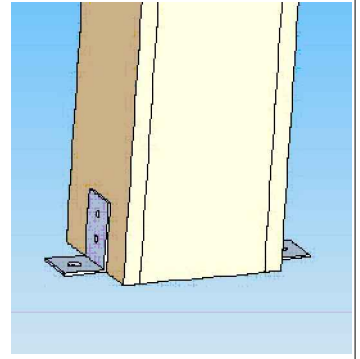
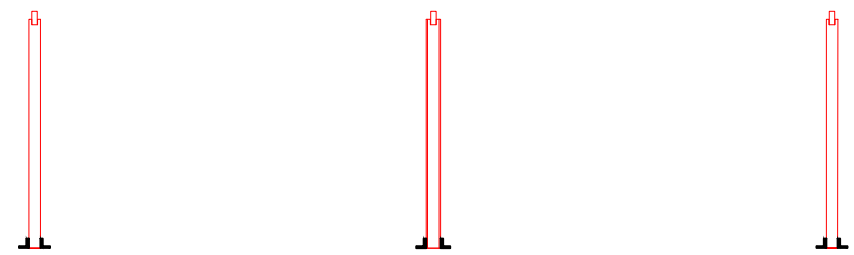

Montage poteau/fixing piles

Arrier/back

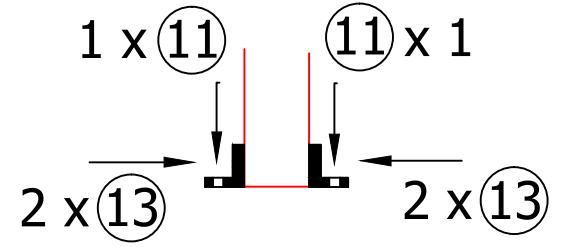
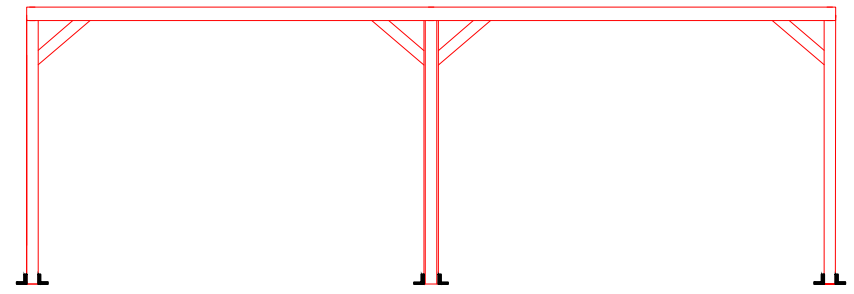

Enface/front

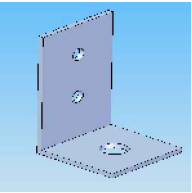

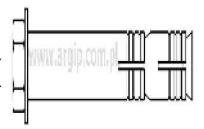
<p>12 x</p> <p>14</p> 	<p>24 x</p> <p>13</p> 	<p>12 x</p> <p>11</p> 
---	---	---



Droit/Right

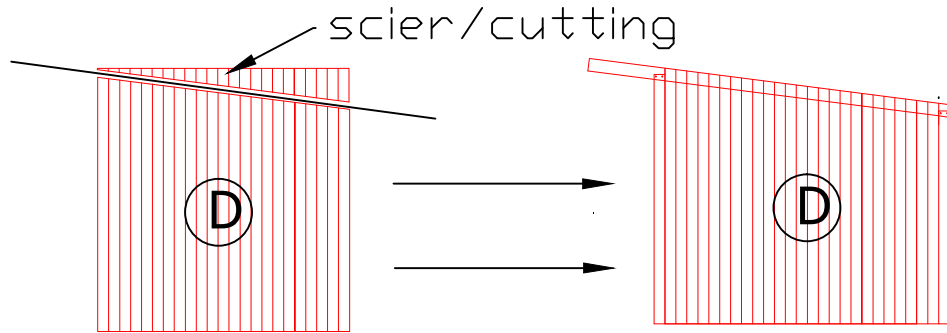
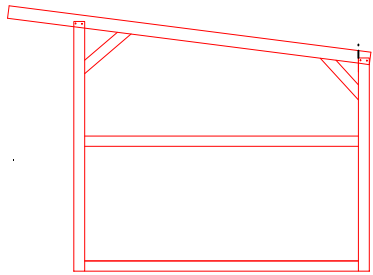
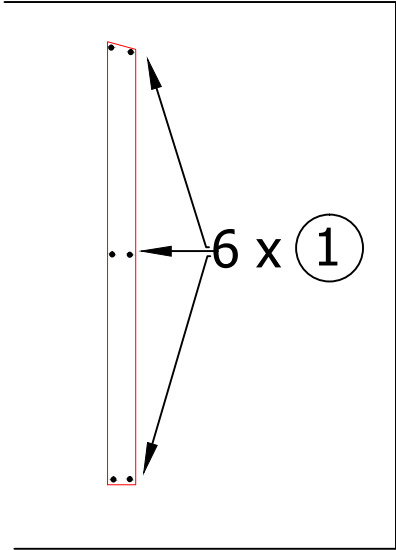

Gauche/Left

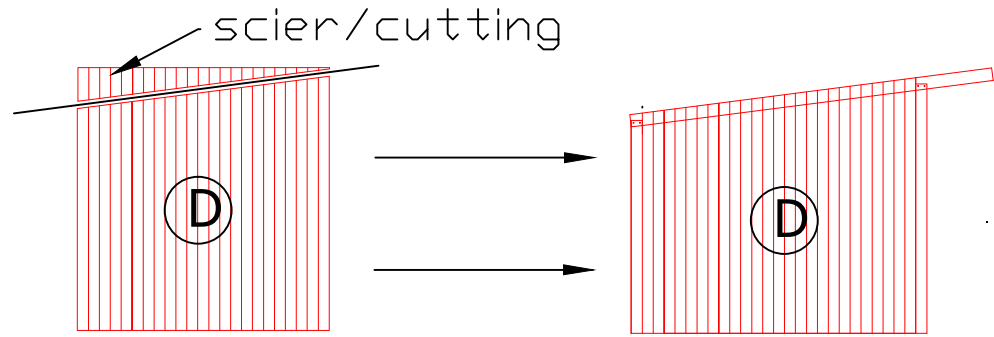
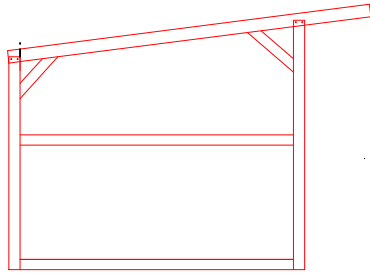

Arrier/back



Planche montage/Planks assembling

D

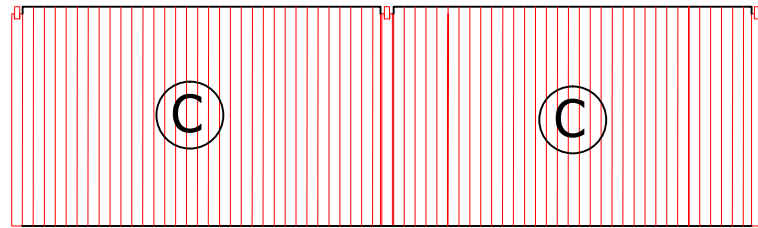
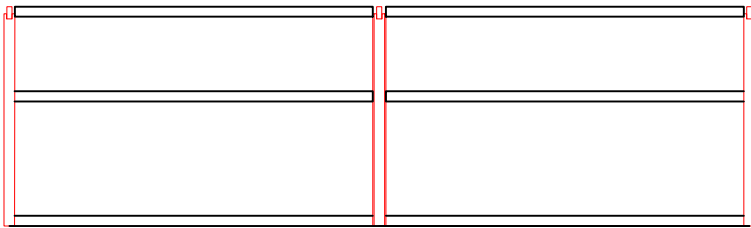

70 x

1



450 x

C

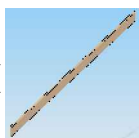

85 x



Roof-assembly steel plates. Toit-montage tole trapeze.

12/13

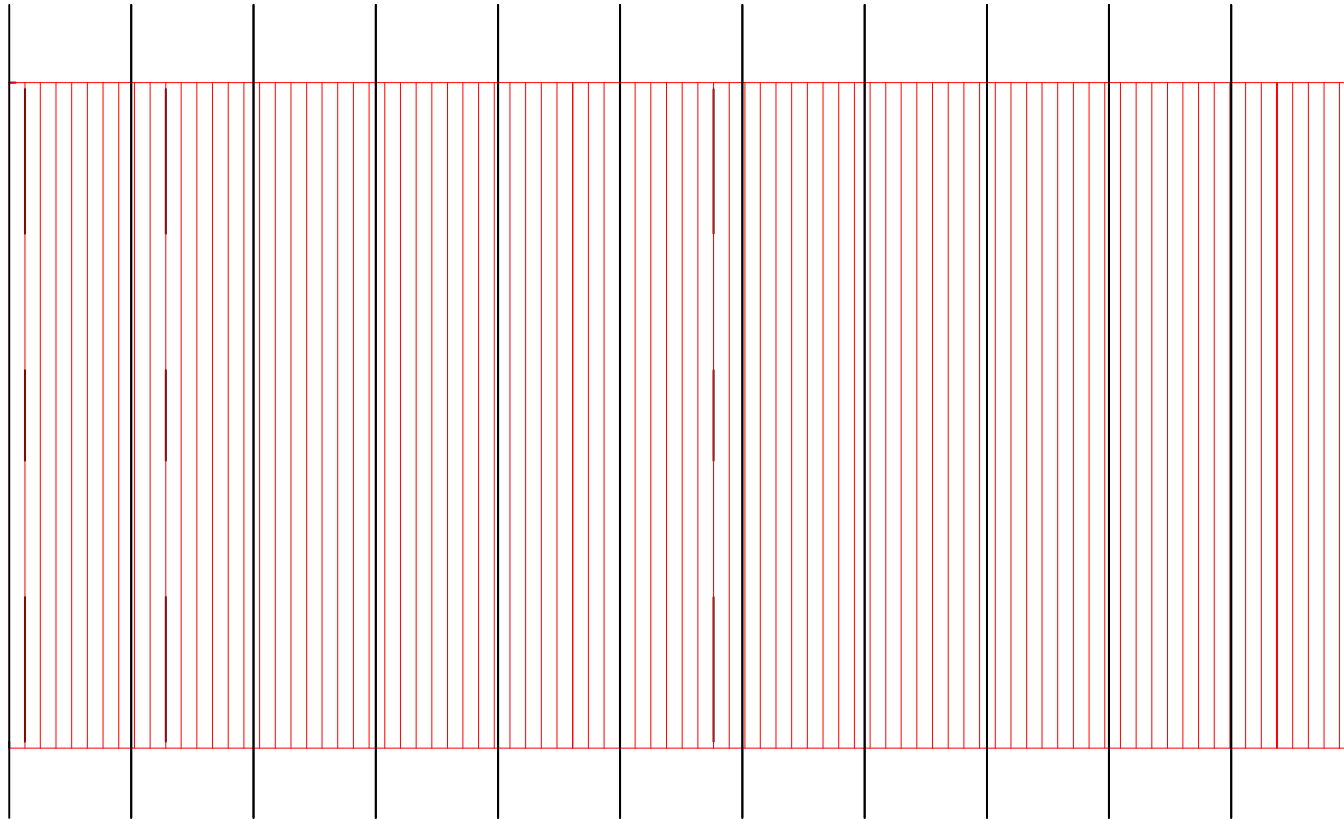

Ⓚ

11 x

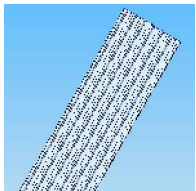

②

180 x



15 x ② per 1 tole trapeze.
per 1 steel plate.

Travail termine/job is done.

