

Example montage
NNUTRITG

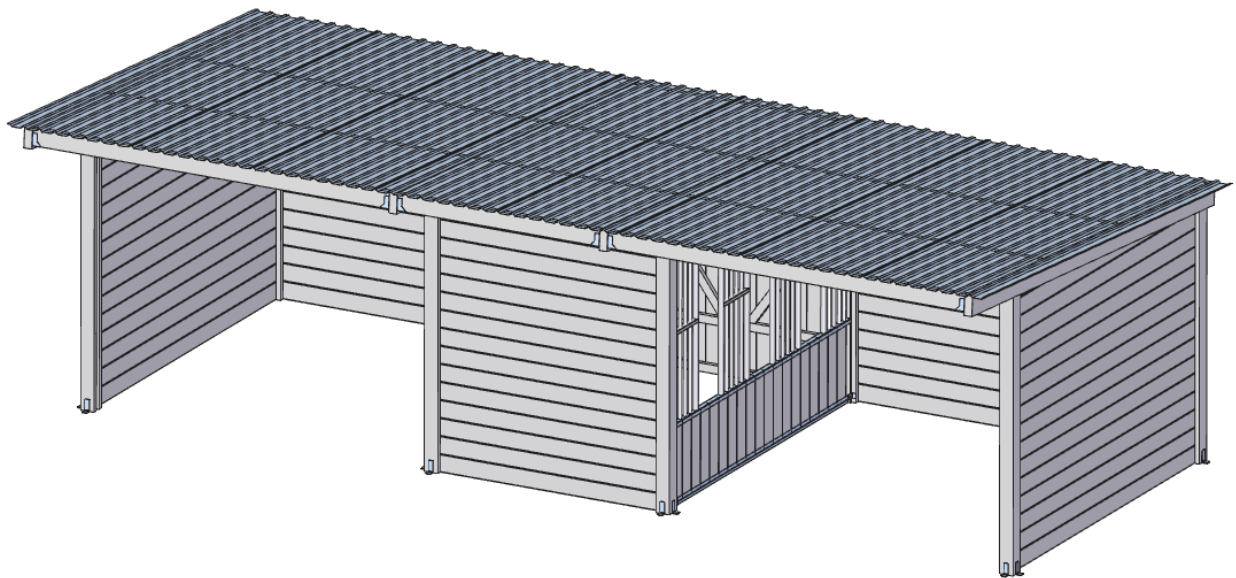

1. Fix columns with angle plates to the ground and push boards between columns

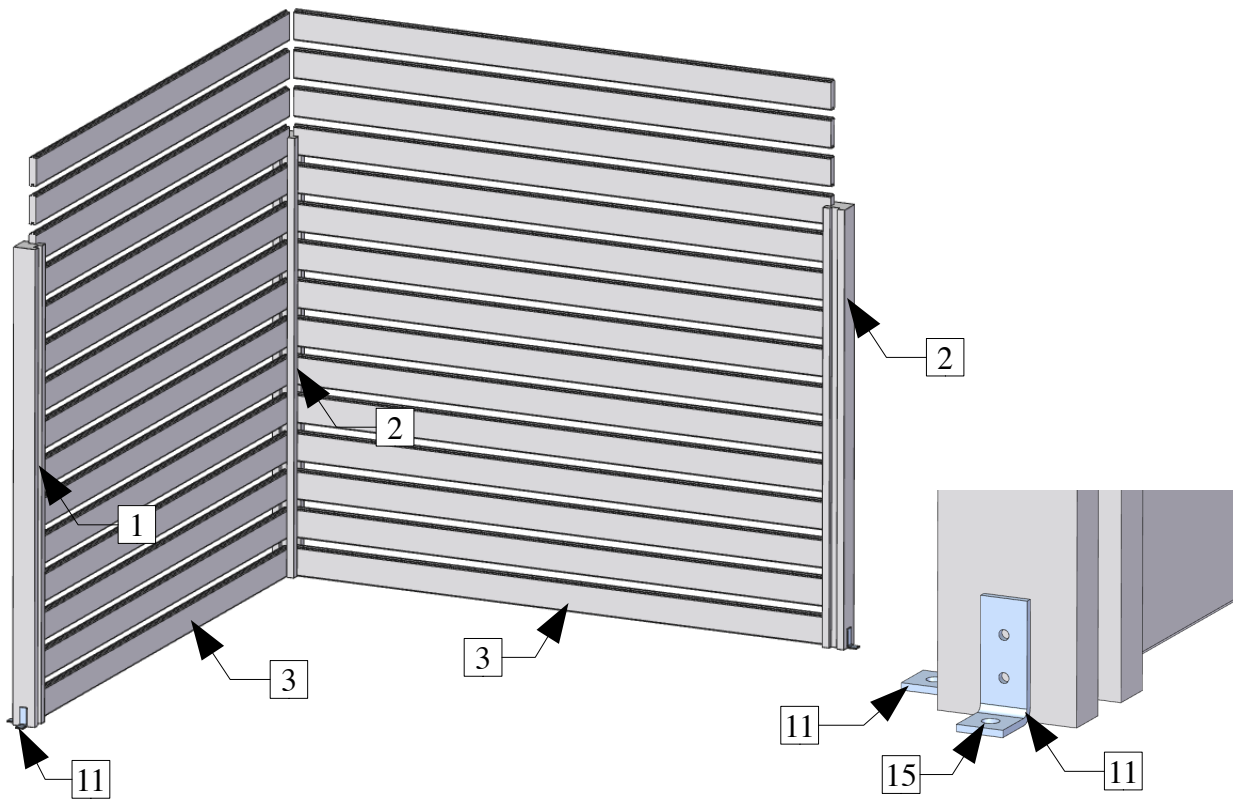

2. Push partition into groove in column and fix with angle plates

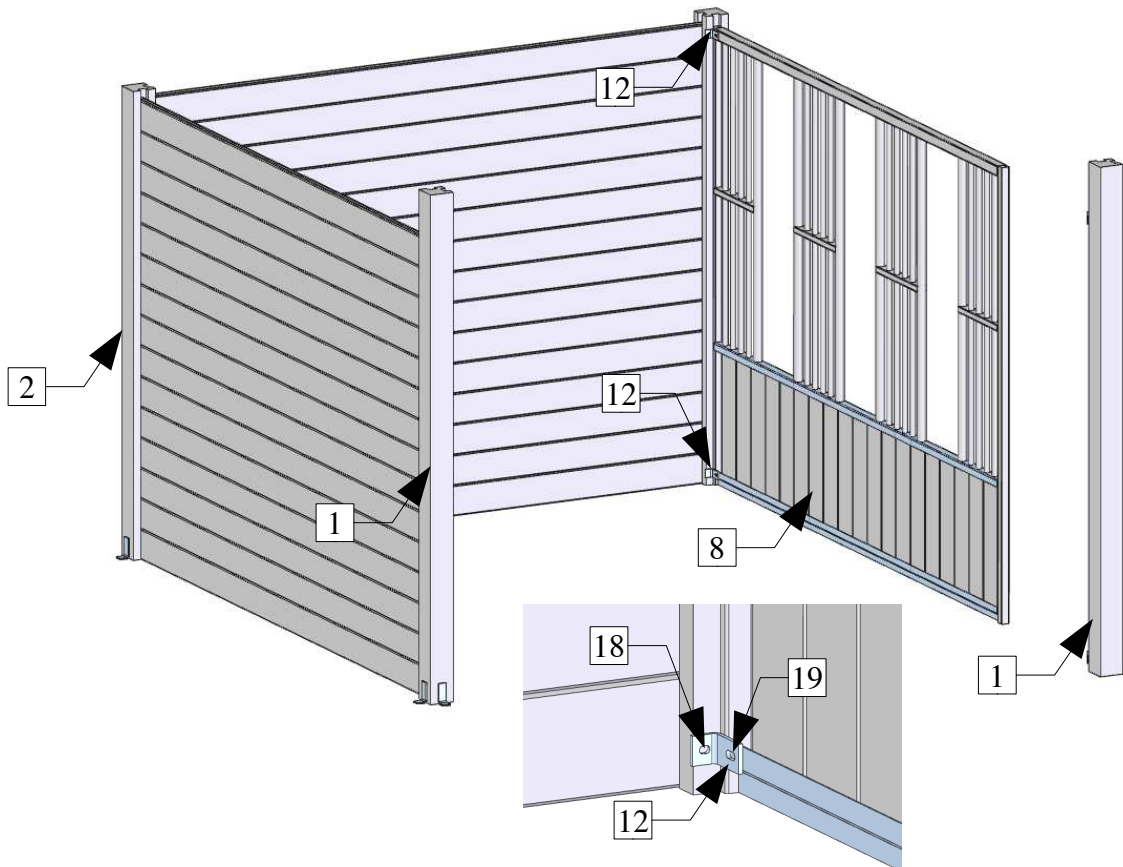

3. Mount columns, partitions and boards for second box

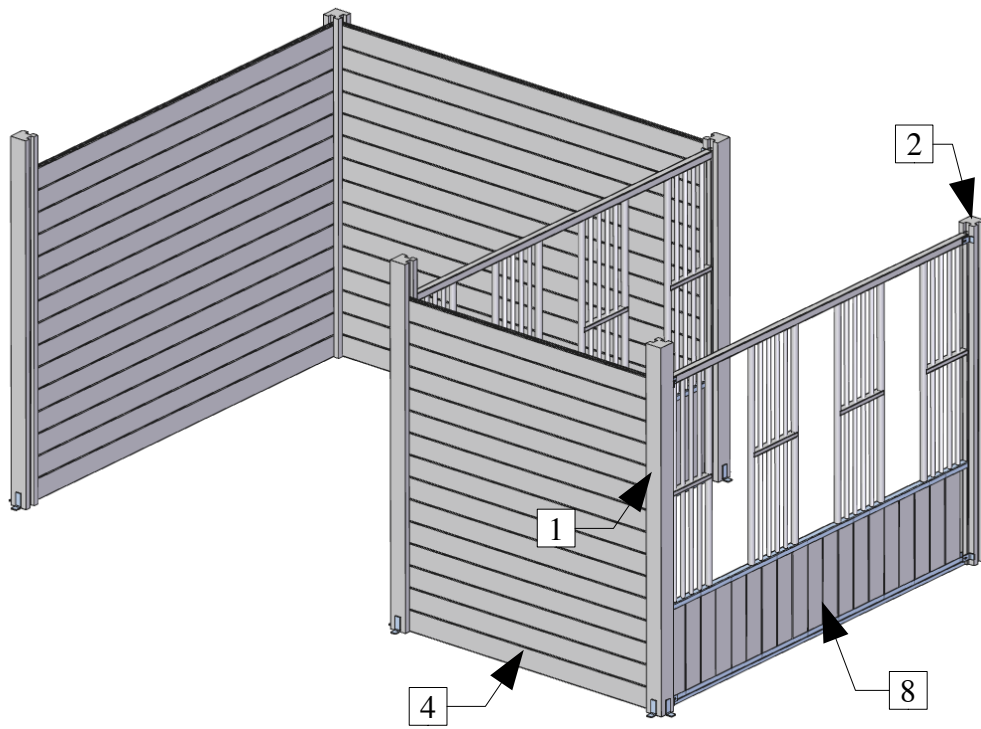

4. Mount columns, partitions and boards for third box

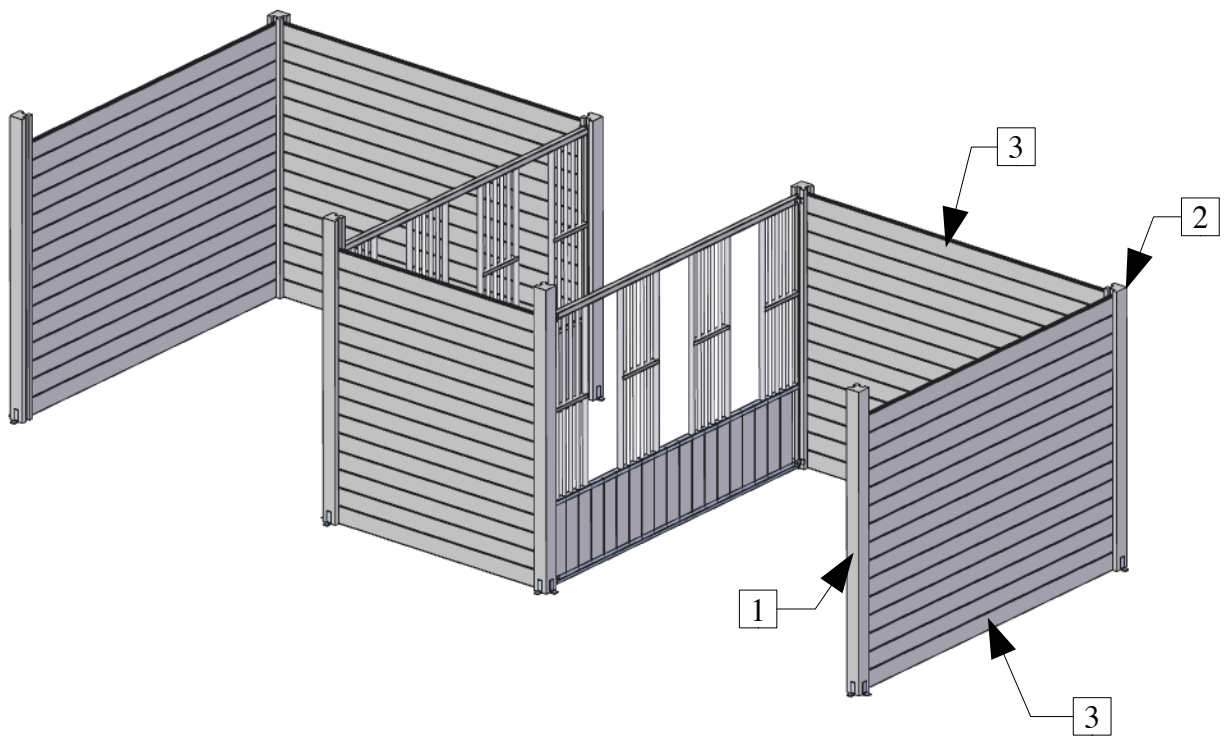

5. Install wooden beams 70x170 to the columns

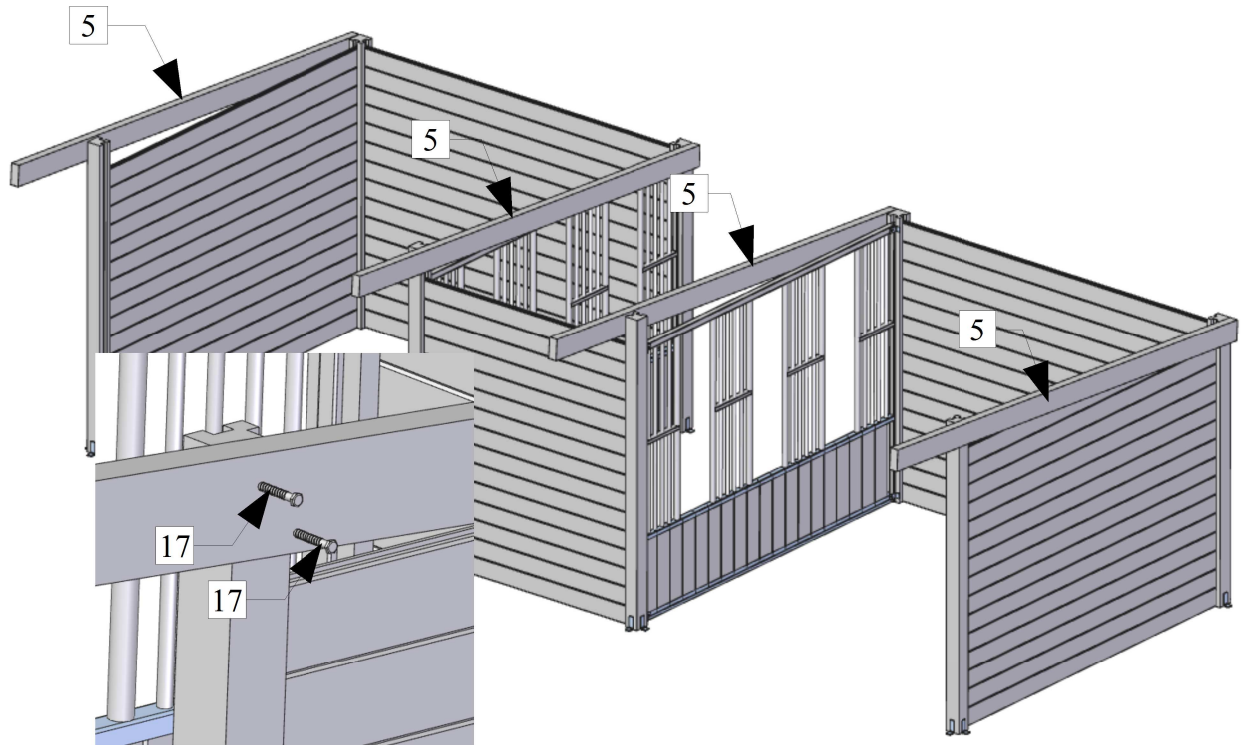

6. Fix purlin holders (BMF) to the rafters

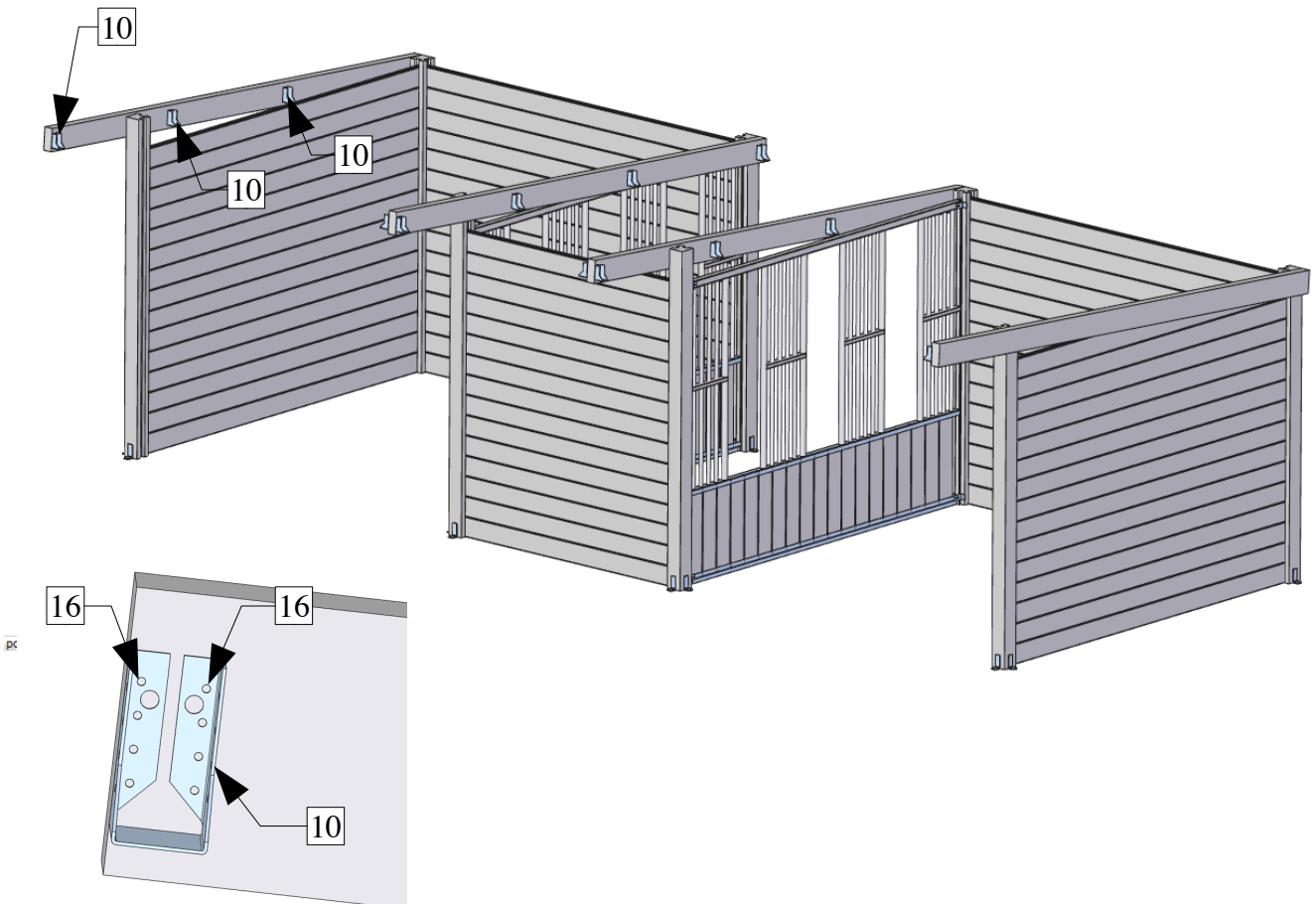

7. Put and screw purlins 48x140 into BMF holders

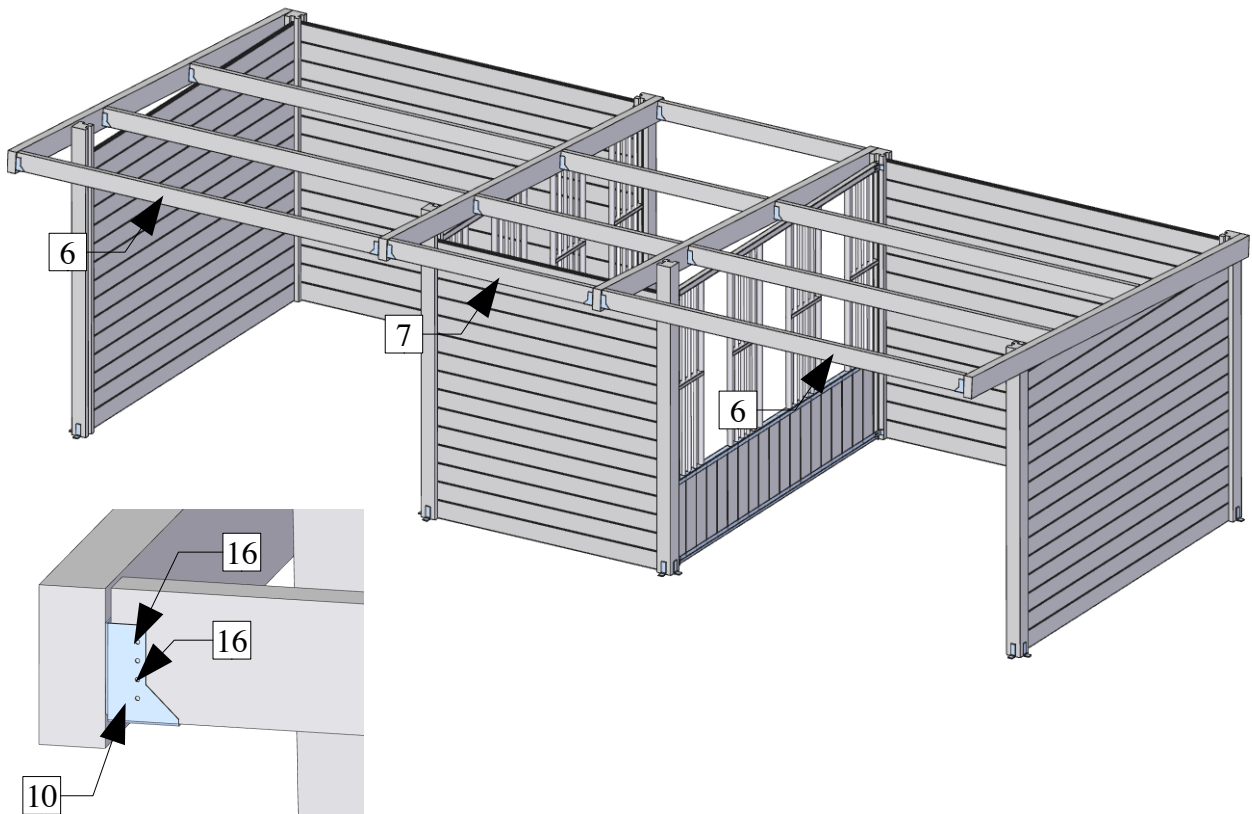

7. Mount doors

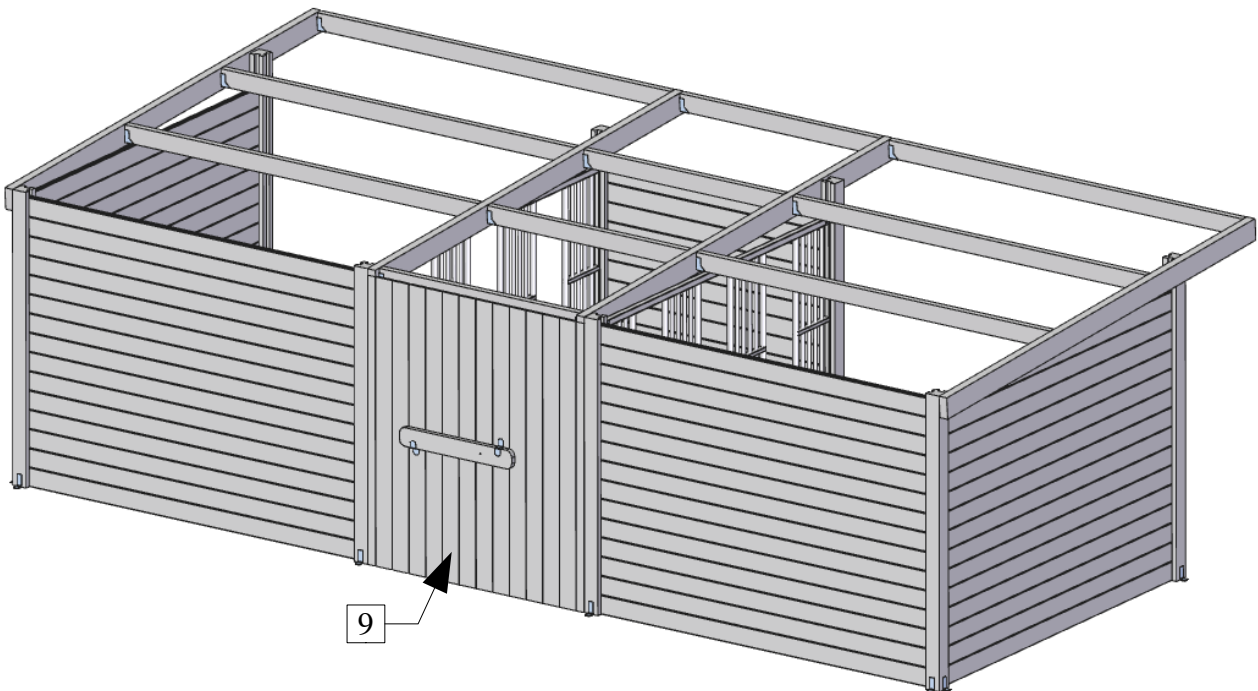

7. Put roofing steel sheets on the purlins and fix with screws (14)

